

aerospace
climate control
electromechanical
filtration
fluid & gas handling
hydraulics
pneumatics
process control
sealing & shielding

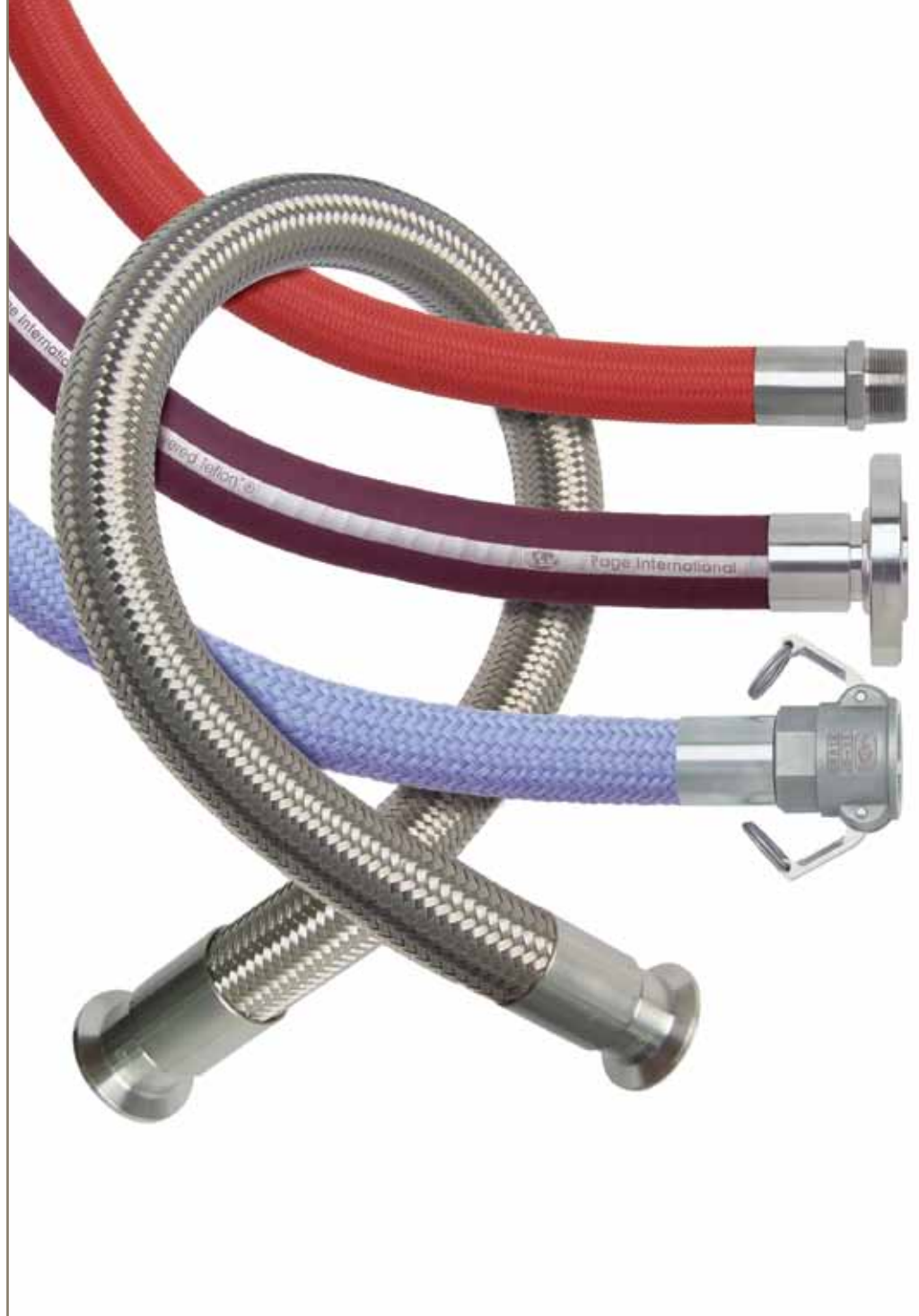

Fluoropolymer Hose & Fittings Products

Flexible Braided Hose, Catalog 5162F

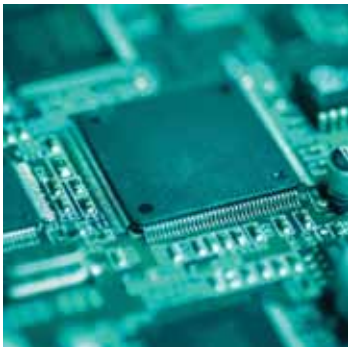

ENGINEERING YOUR SUCCESS.

PARKER/PAGE International is a leading manufacturer of Flexible Fluoroplastic Hose products. As an innovator in the design and production of seamless convoluted hoses and special application assemblies, PARKER/PAGE supplies products to a wide variety of customers around the world. Our experience extends into such diverse markets as chemical manufacturing, pharmaceutical processing, food handling and semiconductor production. From our manufacturing and fabrication facility in Fort Worth, Texas, we offer fluid transport solutions worldwide.

WARNING

FAILURE OR IMPROPER SELECTION OR IMPROPER USE OF THE PRODUCTS AND/OR SYSTEMS DESCRIBED HEREIN OR RELATED ITEMS CAN CAUSE DEATH, PERSONAL INJURY AND PROPERTY DAMAGE.

This document and other information from Parker Hannifin Corporation, its subsidiaries and authorized distributors provide product and/or system options for further investigation by users having technical expertise. It is important that you analyze all aspects of your application and review the information concerning the product or system in the current product catalog. Due to the variety of operating conditions and applications for these products or systems, the user, through its own analysis and testing, is solely responsible for making the final selection of the products and systems and assuring that all performance, safety and warning requirements of the application are met. The products described herein, including without limitation, product features, specifications, designs, availability and pricing, are subject to change by Parker Hannifin Corporation and its subsidiaries at any time without notice.

Offer of Sale

The items described in this document are hereby offered for sale by Parker Hannifin Corporation, its subsidiaries or its authorized distributors. This offer and its acceptance are governed by the provisions stated in the "Offer of Sale".

Copyright 2013, Parker Hannifin Corporation. All rights reserved.





Table of Contents

Intro	Page
	1-10

PAGE "Traditional" Hose & Fittings Page

HOSE

Smooth, True-Bore PTFE Hose	STW/STB	13
Page-Flex® SBF	SBFW/SBFB	14
Convuluted PTFE Hose	SCW/SCB	15
	PCW/PCB	16
	NCW/NCB	17
	SCWV/SCBV	18
	PCWV/PCBV	19
Flare-Seal®	SCWV-FS/SCBV-FS	20
	PCWV-FS/PCBV-FS	21
Silicone Hose	SWPV	23
Rubber Covered Hose	RCTW/RCTB	24

TUBING

Platinum Cured Silicone	SBP	22
--------------------------------	-----	-----------

FITTINGS

PAGE Crimp Fittings	PAGE Series	27
PAGE Collars		38
PAGE Adapters		39

OTHER

Accessories	66
Technical Help	68
Warranty Statement	81
Offer of Sale	84

PAGE "Industrial" Hose & Fittings Page

HOSE

Smoothbore .030 Wall	S30/S30B	42
Smoothbore .040 Wall	S40/S40B	43
High Pressure, up to 4,500 psi	944B	44
High Pressure 5,500 psi	955B	45

TUBING

Convuluted Tubing	CWV/CBV	25
--------------------------	---------	-----------

FITTINGS

Crimp Fittings	91N/91 Series	47
	94 Series	59
	95 Series	59
Field Attachable Fittings	90 Series	60

see back index for detailed listing

We Make Hose Solutions

Standard and Custom Designs

Whether you are purchasing a standard, off the shelf hose, or a custom design, PARKER PAGE hoses deliver the ultimate in life, flexibility and integrity. In fact, PARKER PAGE International Hose is known in the hose industry as a leader in the design and development of application specific PTFE hoses.

Many of our hose solutions have spawned new product lines, such as Page-Flex® SBF, offering a smoothbore flexible hose with the same bend radius of a conventional convoluted hose.

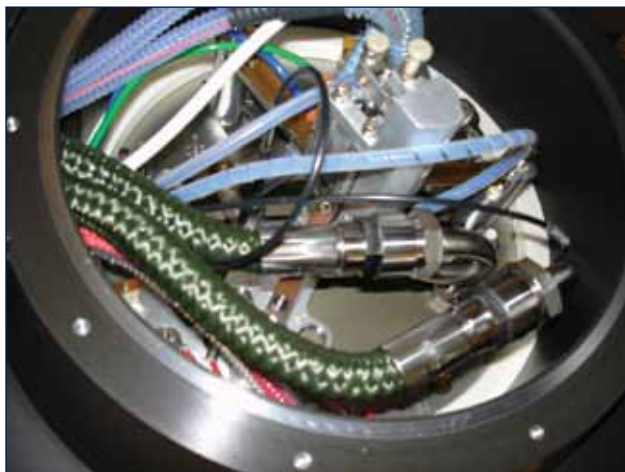

Features

- Chemical Resistant
- Corrosion Resistant
- Handles High Temperatures
- Non-Adhesive
- Easy Cleaning
- Long Life Expectancy



Non Conductive & Conductive

Some applications require conductivity of the tube in order to dissipate static build up. PARKER PAGE International offers a full range of smooth bore and convoluted hoses with non-conductive (natural) and conductive (black) inner core to meet today's most demanding applications.

Industrial grade conductivity meets a minimum conductance of 20 micro amps with 1,000 vdc applied over a 14" length.

We make Custom Hoses to your specifications everyday.



We Make Hose Solutions

Standard and Custom Designs (cont.)

Parker PAGE hoses are available in a True Bore design and in standard nominal size hoses. The first section of this catalog, with blue tables, consist of the True Bore products and fittings. The second section, with red tables, consist of industrial PTFE hoses and fittings. Fittings for these two products are not interchangeable.

True Bore Smoothbore

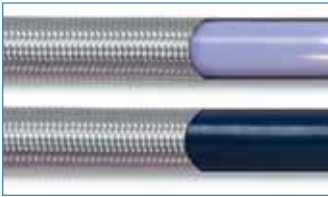

Page 13

PARKER PAGE TRUE BORE Smoothbore PTFE hose has a larger inside diameter (I.D.) than a traditional, nominal hose. The increased I.D. speeds up the flow of the media traveling through the tube; in most cases, hoses carry up to 15% more flow.

Features

- Carries 15% more flow
- Excellent chemical compatibility
- Resists moisture
- Low friction minimizes pressure drops and deposits

Options

- Natural (non-conductive) or black (conductive-static dissipating)
- Braiding - Stainless Steel
- Available with double Stainless braid to handle increased pressures
- Protective/Identifying Sleeving - Fire Sleeve, Heat Shrink and Hose Guards

Industrial Smoothbore



Page 42

Parker PAGE Industrial S30 and S40 hoses look exactly like a True Bore Hose but the inside diameter of the hose is smaller in order to facilitate a Field Attachable Fitting.

Features

- Excellent chemical compatibility
- Resists moisture
- Low friction minimizes pressure drops and deposits
- Can be used with field attachable fittings

Options

- Natural (non-conductive) or black (conductive-static dissipating)
- Available in heavy wall, (33% more PTFE) for a tighter bend radius, greater kink resistance and reduced permeation
- Braiding - Stainless Steel
- Protective/Identifying Sleeving - Fire Sleeve, Heat Shrink and Hose Guards

Convoluted



Page 15

PARKER PAGE International designs and manufactures high quality seamless convoluted hoses that are open pitched and self draining. Standard seamless PTFE braided hoses are extremely lightweight, flexible and kink resistant. PARKER PAGE Convoluted Fluoropolymer PTFE hoses are less susceptible to cracking from stress or flexing than metal hoses or other fluoropolymer hoses when used within designated operating parameters.

Features

- Seamless
- Open-pitched
- Self draining
- Excellent chemical compatibility
- Easy Cleaning
- Non Adhesive

Options

- Natural (non-conductive) or black (conductive-static dissipating)
- Braiding - Stainless Steel or Polypropylene
- Protective/Identifying Sleeving - Fire Sleeve, Heat Shrink and Hose Guards
- Available as tube assembly without braid

Flare-Seal®



PARKER PAGE Flare-Seal® PTFE hose products are designed and manufactured to provide the ultimate in high purity, corrosion/chemical resistance and sanitary applications. The unique benefit offered by a PARKER PAGE Flare-Seal hose is that the PTFE hose liner actually passes through the inside of the fitting and is then flared over the face of the fitting. This special process eliminates the problem of bacterial entrapment and adds the benefit of unrestricted flow by providing 100% PTFE coverage on all wetted surfaces.

Flare-Seal products can be provided with flanged ends or sanitary tri-clamp end connections.

Features

- Flare Seal fitting - Continuous PTFE through fitting; no area for bacterial entrapment
- Seamless inner-core
- Uninterrupted flow
- Excellent chemical compatibility
- Easy Cleaning
- Non Adhesive

Options

- Natural (non-conductive) or black (conductive-static dissipating)
- Flanged ends or sanitary tri-clamp connections
- Braiding - Stainless Steel or Polypropylene

Special non-metallic braids of Nomex®, KEVLAR®, Kynar®, polyester and many others are available upon request.

Page 20



We Make Hose Solutions

Standard and Custom Designs

Platinum Cured Silicone

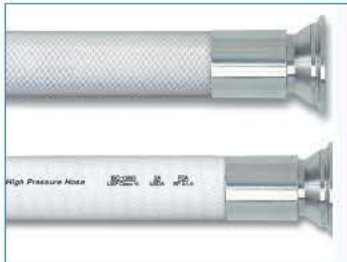

As a compliment to our successful Fluoropolymer and Sanitary Food Grade Hoses, PARKER PAGE offers Platinum Cured Silicone Products. These high quality hoses continue our tradition of total customer satisfaction. PARKER PAGE Fluoropolymer and Platinum Cured hoses meet or exceed the following requirements:

- FDA 21 CFR 177.2600
- ISO 10993 Sections 5, 6 10, 11
- USDA Standards
- USP Class VI Requirements
- 3A Standards

Features

- Easy to clean
- Cover promotes safe operator handling

Options

- Available with double braid

▪ Page 23

Specialty Hoses



PARKER PAGE is recognized as a world leader in the design and manufacture of custom hoses and fittings. Supreme flexibility, superior bend radius, improved vacuum resistance and increased hose life are just a few of the improvements we have made in our hoses over the last couple of years. As demands in the industry change, so do our products. Our engineers are continually surveying the market and creating specialty hoses and fittings to ensure our customers success.

Specialty Hoses

- PAGE-flex® SBF - 1/2" the bend radius of conventional smoothbore hose - Page 14
- EPDM Rubber Covered Hose - Page 24
- Nomex Braided Hose - Page 17
- High Pressure Hose - Page 44



Specialty braiding or patterns



Fire Retardent Sleeving



Custom fittings

PAGE "True Bore" Nomenclature

"True-Bore" & Convoluted Hose Assembly Nomenclature

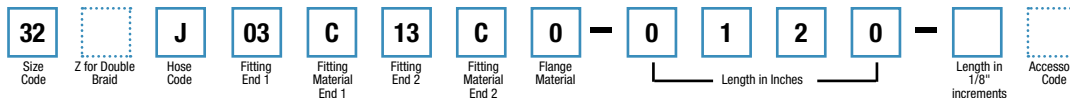
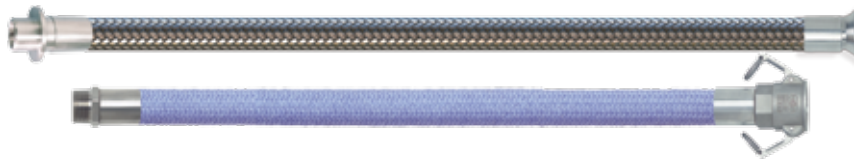

Size Code	
3/16"	03
1/4"	04
5/16"	05
3/8"	06
1/2"	08
5/8"	10
3/4"	12
7/8"	14
1"	16
1-1/4"	20
1-1/2"	24
2"	32
2-1/2"	40
3"	48
4"	64

Hose Code	
ACW	A
CBV	BV
CWV	V
KCB	RB
KCW	R
NCB	MB
NCW	M
PCB	NB
PCBV	PB
PCW	N
PCWV	P
RCTB	GB
RCTW	G
SBFW	SBF
SCB	TB
SCBV	JB
SCW	T
SCWV	J
STB	SB
STW	S

Fitting Code	
Industrial Thread	
Male Pipe NPT Hex	03
Female Pipe NPT Hex	06
Male Pipe NPT Step Down	13
Male Pipe NPT Step Up	23
Male Union Step Up	34
Male Union Step Down	35
JIC Female Swivel	30
Male JIC 37°	31
JIC Female Step Up	32
Male Union	33
Female Union	36
Female NPSH	27
Female ORFS Swivel	80
Male ORFS	81
Male O-Ring Boss	86
Flanges	
Flange Retainer	05
Flare-Seal® Flange Retainer	29
Cam Lock	
Female Cam Lock	07
With Locking Handles	17
Male Cam Lock	08
Sanitary	
Sanitary Tri Clamp	40
Sanitary Tri Clamp 45°	4K
Sanitary Tri Clamp 90°	4L
Sanitary 1-Step Up	4A
Sanitary 2-Step Up	4B
Sanitary 3-Step Up	4C
Sanitary Flare Seal™	4F
Sanitary Mini	42
Sanitary Mini Step Up	43
I-Line Male	48
I-Line Female	49
Bevel Seat Female	45
Bevel Seat Male	46
Tube and Vacuum	
PAGElok™ Tube Adapter	38
PAGElok™ Tube	39
Compression Fitting	
Special Ends	
Standard Cuffed Ends	90
Non Standard Fitting	99

Fitting Material	
304 Stainless (SS 304)	4
316 Stainless (SS 316)	6
316 Stainless (SS 15Ra)	E
Electropolished to 15Ra	
Carbon Steel	C
PFA Encapsulated	T
Hastelloy	H
Monel	M

Accessory Code	
None	
Spring Guard	S
Armor Guard	A
End Bend Restrictors	E
Fire Sleeve	F
Rubber Sleeve	H
FEP Heat Shrink	T
Polyolefin Heat Shrink	P
Silicone Sleeve	M
Vacuum Spring Wire	W
Specials	X

Flange Material	
None	0
Carbon Steel	
Epoxy Coated	D
304SS	4
316SS	6
Kynar	K
Polypropylene	P
Non Standard	X

Example: 32J03C13C0-0120-A
Size: 2" **Style:** SCWV
Braid: 316 SS Single Braid
Core: Heavy Wall Open Pitch Convoluted PTFE
End 1: 2" Male Pipe NPT Hex
End 2: 2" Male Pipe NPT Step Down

Length: 120" from end of Male NPT to end of Male Step Down

Accessory: Full Length Armor Guard

NOTE: Length calculations for PAGE hose assemblies are typically made sealing surface to sealing surface per the NAHAD Fluoropolymer Hose Assembly Specification Guidelines unless otherwise requested by customer at time of order.



PAGE S30 & S40 Nomenclature

PAGE Industrial S30 & S40 Hose Assembly Nomenclature

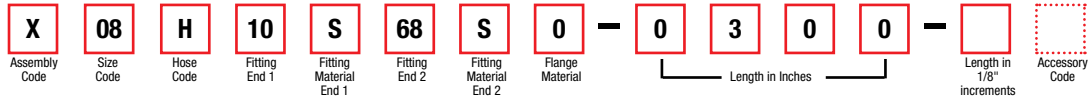

Assembly Code	
Permanently Attached	X
Field Attachable	FA

Size Code	
1/8"	03
3/16"	04
1/4"	05
5/16"	06
13/32"	08
1/2"	10
5/8"	12
7/8"	16
1-1/8"	20

Hose Code	
S30	S
S30B	SB
S40	H
S40B	HB
ZS40	R
ZS40B	RB
944B	944B
955B	955B

Fitting Code	
Pipe Thread Fittings	
Male Pipe NPT Hex	10
Male Pipe NPT Step Up	15
Male Pipe NPT Step Down	20
Male Union	11
Male Union 45°	14
Male Union 90°	19
Male Union Step Up	16
Male Union Step Down	21
Female Pipe NPT Hex	55
Female Pipe Step Up	58
Female Pipe Step Down	59
Female Union	80
Female Union Step Up	84
Female Union Step Down	88
JIC Fittings	
JIC Female Swivel	68
JIC Female 45° Elbow	66
JIC Female 90° Elbow	67
SAE Female Swivel	69
SAE Female 45° Elbow	70
SAE Female 90° Elbow	71
JIC Female Step Up	64
JIC Female Step Down	65
Tube Stub Fittings	
Tube Stub	91
Tube Stub Step Up	93
Tube Stub Step Down	95
SAE Male Compression	96
Inverted Flare & Power Trim Fittings	
Male Straight	76

Fitting Material	
Stainless (SS)	S
Brass	B
Carbon Steel	C

Accessory Code	
None	
Spring Guard	S
Armor Guard	A
End Bend Restrictors	E
Fire Sleeve	F
Rubber Sleeve	H
FEP Heat Shrink	T
Polyolefin Heat Shrink	P
Silicone Sleeve	M
Internal Spring	I
Vacuum Spring Wire	W
Specials	X

Example: X08H10S68S0-0300

Size: 08 (13/32 I.D.) **Style:** S40

Braid: SS Single Braid

Core: Heavy Wall Smoothbore Convuluted PTFE

End 1: 1/2" 316 SS Male NPT

End 2: 1/2" 316 SS Female 37° Seat JIC Swivel

Length: 300" from end of Male Pipe to seat of Female JIC

NOTE: Length calculations for PAGE hose assemblies are typically made sealing surface to sealing surface per the NAHAD Fluoropolymer Hose Assembly Specification Guidelines unless otherwise requested by customer at time of order.

PAGE Silicone Products Nomenclature

PAGE SBP & SWPV Hose Assembly Nomenclature

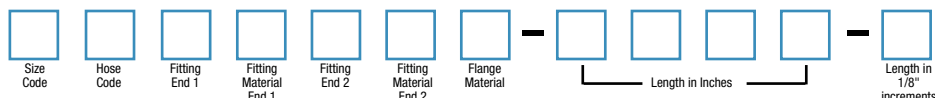

Size Code	
1/4"	04
5/16"	05
3/8"	06
1/2"	08
3/4"	12
1"	16
1-1/4"	20
1-1/2"	24
2"	32
2-1/2"	40
3"	48
4"	64

Hose Code	
SBP	C
SWPV	E

Fitting Code	
Industrial Thread	
Male Pipe NPT Hex	03
Female Pipe NPT Hex	06
Male Pipe NPT Step Down	13
Male Pipe NPT Step Up	23
Male Union Step Up	34
Male Union Step Down	35
JIC Female Swivel	30
JIC Female Step Up	32
Male Union	33
Female Union	36
Female NPSH	37
Female ORFS Swivel	80
Male ORFS	81
Male O-Ring Boss	86
Flanges	
Flange Retainer	05
Flare-Seal Flange Retainer	29
Cam Lock	
Female Cam Lock	07
With Locking Handles	17
Male Cam Lock	08
Sanitary	
Sanitary Tri Clamp	40
Sanitary Tri Clamp 45°	4K
Sanitary Tri Clamp 90°	4L
Sanitary 1-Step Up	4A
Sanitary 2-Step Up	4B
Sanitary 3-Step Up	4C
Sanitary Flare Seal™	4F
Sanitary Mini	42
Sanitary Mini Step Up	43
I-Line Male	48
I-Line Female	49
Bevel Seat Female	45
Bevel Seat Male	46
Tube and Vacuum	
PAGElok™ Tube Adapter	38
PAGElok™ Tube Compression Fitting	39

Fitting Material	
304 Stainless (SS 304)	4
316 Stainless (SS 316)	6
316 Stainless (SS) Electropolished to 15Ra	E
Carbon Steel	C
Teflon Encapsulated	T
Hastelloy	H
Monel	M

Flange Material	
None	0
Carbon Steel Epoxy Coated	D
304SS	4
316SS	6
Kynar	K
Polypropylene	P
Non Standard	X

Example: 16E4064L60-0060-4

Size: 1" **Style:** SWPV

Construction: Wrapped Platinum Cured Silicone Hose with SS Vacuum wire

End 1: 1" 316SS Sanitary Tri Clamp Fitting

End 2: 1" 316SS Sanitary Tri Clamp 90° Elbow Fitting

Length: 60-1/2" from end of Straight Tri-Clamp to center line of 90° Elbow Tri-Clamp

NOTE: Length calculations for PAGE hose assemblies are typically made sealing surface to sealing surface per the NAHAD Fluoropolymer Hose Assembly Specification Guidelines unless otherwise requested by customer at time of order.



PAGE Hose

Working Pressures (psi)

Reinforcement Type		PSI Fluoropolymer Hose Working Pressures														
		Fractional Size	Nominal Sizes													
			1/8	3/16	1/4	5/16	13/32	1/2	5/8	7/8	1-1/8	1/8	1/4	3/8	1/2	5/8
		Dash Size	-3	-4	-5	-6	-8	-10	-12	-16	-20	-3	-4	-6	-8	-10
		PSI	PSI	PSI	PSI	PSI	PSI	PSI	PSI	PSI	PSI	PSI	PSI	PSI	PSI	
Wire Braid	944B	High Pressure PTFE Hose with static-dissipative core		4500		4500	4500	4500	4500	4000						
	955B	High Pressure PTFE Hose with static-dissipative core		5500		5500	5500	5500	5500							
	S30	PAGE Ind. PTFE Hose	3000	3000	3000	2500	2000	1750	1500	1000						
	S30B	PAGE Ind. PTFE Hose with static-dissipative core	3000	3000	3000	2500	2000	1750	1500	1000						
	S40	PAGE Ind. Heavy Wall PTFE Hose	3000	3000	3000	2500	2000	1750	1500	1000						
	S40B	PAGE Ind. Heavy Wall PTFE Hose with static-dissipative core	3000	3000	3000	2500	2000	1750	1500	1000						
	STW Z-STW*	PAGE Heavy Wall PTFE Hose *Double Braid										3000	3000	2000	1750	
	STB Z-STB*	PAGE Heavy Wall PTFE Hose with static-dissipative core *Double Braid										3000	3000	2000	1750	
	SCW	PAGE Convoluted PTFE Hose											1500	1500	1500	
	SCB	PAGE Convoluted PTFE Hose with static-dissipative core											1500	1500	1500	
	SCWV	PAGE Heavy Wall Convoluted PTFE Hose													1500	
	SCBV	PAGE Heavy Wall Convoluted PTFE Hose with static-dissipative core													1500	
	SCWV-FS	PAGE Flare-Seal® PTFE Hose													500	
	SCBV-FS	PAGE Flare-Seal® PTFE Hose with static-dissipative core													500	
Fiber	NCW	PAGE Convoluted PTFE Hose, Nomex Braid	contact Customer Service													
	NCB	PAGE Convoluted PTFE Hose with static-dissipative core, Nomex Braid	contact Customer Service													
	PCW	PAGE Convoluted PTFE Hose, PP Braid										350	350	300		
	PCB	PAGE Convoluted PTFE Hose with static-dissipative core, PP Braid										350	350	300		
	PCWV	PAGE Heavy Wall Convoluted PTFE Hose, PP Braid												300		
	PCBV	PAGE Heavy Wall Convoluted PTFE Hose with static-dissipative core, PP Braid												300		
	PCWV-FS	PAGE Flare-Seal® PTFE Hose, PP Braid												300		
	PCBV-FS	PAGE Flare-Seal® PTFE Hose with static-dissipative core, PP Braid												300		
Other	RCTW	PAGE Rubber Covered EPDM												500		
	RCTB	PAGE Rubber Covered EPDM with static-dissipative core												500		
	SBFW	PAGE Page-Flex® SBF											300	300		
	SBFB	PAGE Page-Flex® SBF with static-dissipative core											300	300		
	SBP	Platinum Cured Braided Silicone										160	150	140		
	SWPV	Platinum Cured 4 Ply Silicone with SS Wire Helix											250	250		
	CWV	Convoluted tubing - no reinforcement													50	

*Z indicates double braid.

Legend

EPDM - Ethylene Propylene Diene Monomer Rubber
 PTFE - Polytetrafluoroethylene
 PTFE-S - Polytetrafluoroethylene, Static Dissipative
 FEP - Fluorinated Ethylene Propylene

PFA - Perfluoroalkoxy
 PFA-S - Perfluoroalkoxy, Static Dissipative
 PP - Polypropylene
 S - Silicone
 SS - Stainless Steel

PAGE Hose

Construction and Specifications

PSI Fluoropolymer Construction and Specifications														Reinforcement Type
3/4	1	1 1/4	1 1/2	2	2-1/2	3	4					Fractional Size		
-12	-16	-20	-24	-32	-40	-48	-64	Core Tube	Reinforcement Material	Cover Material	Page #	Dash Size		
PSI	PSI	PSI	PSI	PSI	PSI	PSI	PSI							
								PTFE-S	SS Wire	—	44	High Pressure PTFE Hose with static-dissipative core	944B	
								PTFE-S	SS Wire	—	45	High Pressure PTFE Hose with static-dissipative core	955B	
								PTFE	SS Wire	—	42	PAGE Ind. PTFE Hose	S30	
								PTFE-S	SS Wire	—	42	PAGE Ind. PTFE Hose with static-dissipative core	S30B	
								PTFE	SS Wire	—	43	PAGE Ind. Heavy Wall PTFE Hose	S40	
								PTFE-S	SS Wire	—	43	PAGE Ind. Heavy Wall PTFE Hose with static-dissipative core	S40B	
1000	1000 1200*	1000*	900*					PTFE	SS Wire	—	13	PAGE Heavy Wall PTFE Hose *Double Braid	STW Z-STW*	
1000	1000 1200*	1000*	900*					PTFE-S	SS Wire	—	13	PAGE Heavy Wall PTFE Hose with static-dissipative core *Double Braid	STB Z-STB*	
1200	1000	750	650	450				PTFE	SS Wire	—	15	PAGE Convoluted PTFE Hose	SCW	
1200	1000	750	650	450				PTFE-S	SS Wire	—	15	PAGE Convoluted PTFE Hose with static-dissipative core	SCB	
1200	1000	750	650	450	200	175	150	PTFE	SS Wire	—	18	PAGE Heavy Wall Convoluted PTFE Hose	SCWV	
1200	1000	750	650	450	200	175	150	PTFE-S	SS Wire	—	18	PAGE Heavy Wall Convoluted PTFE Hose with static-dissipative core	SCBV	
425	350	325	300	250	200	175	150	PTFE	SS Wire	—	20	PAGE Flare-Seal® PTFE Hose	SCWV-FS	
425	350	325	300	250	200	175	150	PTFE-S	SS Wire	—	20	PAGE Flare-Seal® PTFE Hose with static-dissipative core	SCBV-FS	
								PTFE	Nomex		17	PAGE Convoluted PTFE Hose, Nomex Braid	NCW	
								PTFE-S	Nomex		17	PAGE Convoluted PTFE Hose with static-dissipative core, Nomex Braid	NCB	
250	250	200	200	200	200	200	200	PTFE	PP	—	16	PAGE Convoluted PTFE Hose, PP Braid	PCW	
250	250	200	200	200	200	200	200	PTFE-S	PP	—	16	PAGE Convoluted PTFE Hose with static-dissipative core, PP Braid	PCB	
250	250	200	200	200	150	125	100	PTFE	PP	—	19	PAGE Heavy Wall Convoluted PTFE Hose, PP Braid	PCWV	
250	250	200	200	200	150	125	100	PTFE-S	PP	—	19	PAGE Heavy Wall Convoluted PTFE Hose with static-dissipative core, PP Braid	PCBV	
250	250	200	200	200	150	125	100	PTFE	PP	—	21	PAGE Flare-Seal® PTFE Hose, PP Braid	PCWV-FS	
250	250	200	200	200	150	125	100	PTFE-S	PP	—	21	PAGE Flare-Seal® PTFE Hose with static-dissipative core, PP Braid	PCBV-FS	
500	450	375	375	300	200	200	150	FEP	Double Wire Helix	EPDM	24	PAGE Rubber Covered EPDM	RCTW	
500	450	375	375	300	200	200	150	PFA-S	Double Wire Helix	EPDM	24	PAGE Rubber Covered EPDM with static-dissipative core	RCTB	
250	250		200					PFA	Bonded Wire-Silicone-Fiber	—	14	PAGE Page-Flex® SBF	SBFW	
250	250		200					PFA-S	Bonded Wire-Silicone-Fiber	—	14	PAGE Page-Flex® SBF with static-dissipative core	SBFB	
100	60							PTFE	SS Wire	S	22	Platinum Cured Braided Silicone	SBP	
250	250		250	230				PTFE	SS Wire	S	23	Platinum Cured 4 Ply Silicone with SS Wire Helix	SWPV	
50	50	40	40	30	20	15	10	PTFE	None	—	25	Convoluted tubing - no reinforcement	CWV	



PAGE Hose Fitting Selection Chart

Hose Series	Description	Crimp Fitting	Crimp Collar	Crimpers		Factory Assembly Only	Field Attachable Fitting
				Parkrimp	Adjustable		
944B	High Pressure PTFE Hose, up to 4,500 psi	94 Series (page 59)	-	No	Factory crimp only	Yes	Not applicable
955B	High Pressure PTFE Hose, 5,500 psi	95 Series (page 59)	-	No	Factory crimp only	Yes	Not applicable
S30/S30B	Smoothbore Nominal (0.030 wall)	91N/91 Series (page 47)	-	Yes	COS-K4 with special dies required	No	90 Series (page 60)
S40/S40B	Smoothbore Nominal (0.040 wall)	91N/91 Series (page 47)	-	Yes	COS-K4 with special dies required	No	Not applicable
STW/STB	Smoothbore True Bore	PAGE Series - Two piece crimp fittings (page 27)	ST300	No	Yes	No	Not applicable
SCW/SCB	Convuluted	PAGE Series - Two piece crimp fittings (page 27)	SC300	No	Yes	No	Not applicable
PCW/PCB	Convuluted	PAGE Series - Two piece crimp fittings (page 27)	PC300	No	Yes	No	Not applicable
SBP/SWPV	Platinum Cured Silicone	PAGE Series - Two piece crimp fittings (page 27)	SIL300	No	Yes	No	Not applicable
RCTW/RCTB	Rubber Covered Fluoropolymer	PAGE Series - Two piece crimp fittings (page 27)	RC300	No	Yes	No	Not applicable
SCWW/SCBV	Convuluted Heavy Wall	PAGE Series - Two piece crimp fittings (page 27)	SC300	No	Yes	Yes	Not applicable
PCWW/PCBV	Convuluted Heavy Wall	PAGE Series - Two piece crimp fittings (page 27)	PC300	No	Yes	Yes	Not applicable



PAGE “True-Bore” HOSE & FITTINGS



Visual Index

PAGE Product Line PTFE & Specialty	S30 Industrial .030 wall with SS Braid  pg. 42	S30B Conductive Industrial .030 wall with SS Braid  pg. 42	S40 Heavy Wall .040 with SS Braid  pg. 43
	S40B Conductive Heavy Wall .040 with SS Braid  pg. 43	STW "True-Bore" with SS Braid  pg. 13	STB Conductive "True-Bore" with SS Braid  pg. 13
SBFB Conductive PAGE-flex® SBF  pg. 14	SCW Convoluted with SS Braid  pg. 15	SCB Conductive Convoluted with SS Braid  pg. 15	PCW Convoluted with PP Braid  pg. 16
PCB Conductive Convoluted with PP Braid  pg. 16	NCW Convoluted with Nomex Braid  pg. 17	NCB Conductive Convoluted with Nomex Braid  pg. 17	SCWV Heavy Wall Convoluted with SS Braid  pg. 18
SCBV Conductive Heavy Wall Convoluted with SS Braid  pg. 18	PCWV Heavy Wall Convoluted with PP Braid  pg. 19	PCBV Conductive Heavy Wall Convoluted with PP Braid  pg. 19	SCWV-FS Flare-Seal® with SS Braid  pg. 20
SCBV-FS Conductive Flare-Seal® with SS Braid  pg. 20	PCWV-FS Flare-Seal® with PP Braid  pg. 21	PCBV-FS Conductive Flare-Seal® with PP Braid  pg. 21	SBP Platinum Cured Braided Silicone Tubing  pg. 22
SWPV Platinum Cured 4 Ply Silicone w/ SS Helix  pg. 23	RCTW EPDM Rubber Covered Natural  pg. 24	RCTB EPDM Rubber Covered Conductive  pg. 24	CWV Convoluted Tubing  pg. 25
CBV Conductive Convoluted Tubing  pg. 25			

All dimensions nominal - Working pressures and vacuum ratings may vary depending upon end connections and process and temperature parameters.

STW/STB - "TRUE BORE"

Smoothbore PTFE Hose, Stainless Steel Braid



Features

- High temperature hose
- Excellent chemical compatibility
- Resists moisture
- Low friction minimizes pressure drops and deposits

Compliances

- FDA 21 CFR 177.1550
- USP Class VI
- ISO 10993 Sections 5, 6, 10, 11

Applications/Markets



- Food & Beverage
- Pharmaceutical
- Fluid handling
- Chemical transfer
- Cosmetics
- Paint

Part Number		Nominal I.D.		Nominal O.D.		Maximum Working Pressure 72°F/ 23°C		Minimum Bend Radius		Vac. Rating Hg./72°F	Weight		Permanent Fitting Series
#	#	⊙		⊙		⊙		↘		U	lbs	kg	⊙
Natural	Conductive	inch	mm	inch	mm	psi	bar	inch	mm	inch	lbs./ft.	kg./mtr.	
03-STW	03-STB	1/8	3	.25	6	3,000	207	1-1/2	38	28	.05	.08	NA
04-STW	04-STB	1/4	6	.37	9	3,000	207	3	76	28	.08	.13	PAGE
06-STW	06-STB	3/8	10	.51	13	2,000	138	5	127	28	.11	.16	PAGE
08-STW	08-STB	1/2	13	.63	16	1,750	121	6-1/2	165	28	.16	.24	PAGE
12-STW	12-STB	3/4	19	.88	22	1,000	69	8.5	216	28	.20	.30	PAGE
16-STW	16-STB	1	25	1.13	29	1,000	69	12	305	20	.33	.49	PAGE
16Z-STW	16Z-STB	1	25	1.22	31	1,000	69	12	305	20	.56	.83	PAGE
20Z-STW	20Z-STB	1-1/4	32	1.52	38	1,000	69	14	356	18	.68	1.02	PAGE
24Z-STW	24Z-STB	1-1/2	38	1.73	44	900	62	15	381	15	.79	1.18	PAGE

Construction

Tube: STW - Natural FDA Compliant PTFE

STB - Black Static-Dissipative PTFE

Reinforcement: 304 Stainless Steel braid

Operating Parameters

Temperature Range:

-100°F to +450°F (-73°C to +232°C)

Min. Burst Pressure is 4x Max. Working Pressure at 72°F (23°C)

All ratings based on 72°F/23°C

Change in length at working pressure is +2% to -4%

Fittings

PAGE Series - page 30

Uses crimp collar ST300 - page 38

Notes

"Z" indicates double braid

See page 5 for part numbering system

Cannot be used with 90 or 91N series fittings

All dimensions nominal - Working pressures and vacuum ratings may vary depending upon end connections and process and temperature parameters.



SBFW/SBFB - Page-Flex® SBF

Extra Flexible Fluoropolymer Hose



Features

- Half the minimum bend radius of conventional smoothbore products
- Kink and vacuum resistant
- Easily cleaned
- PPIH full line of optional reinforcement types
- Cooler outside temperatures reduces operator burns
- Reduces environment temperatures in confined areas
- Available with white Silicone jacket

Compliances

- FDA 21 CFR 177.1550
- **USP Class VI Certified**
- ISO 10993 Sections 5, 6, 10, 11

Specialty

Applications/Markets



- Food & Beverage
- Pharmaceutical
- Fluid handling
- Chemical transfer
- Cosmetics
- Paint

Part Number		Nominal I.D.		Nominal O.D.		Maximum Working Pressure 72°F/ 23°C		Minimum Bend Radius		Vac. Rating Hg./72°F	Weight	
#	#	⊙		⊙		↻		↻		U	lbs	kg
Natural	Conductive	inch	mm	inch	mm	psi	bar	inch	mm	inch	lbs./ft.	kg./mtr.
06-SBFW	06-SBFB	3/8	10	.63	16	300	21	2	51	28	.16	.24
08-SBFW	08-SBFB	1/2	13	.76	19	300	21	2-1/2	64	28	.23	.34
12-SBFW	12-SBFB	3/4	19	1.04	26	250	17	3	76	28	.37	.55
16-SBFW	16-SBFB	1	25	1.29	33	250	17	4	102	28	.54	.80
24-SBFW	24-SBFB	1-1/2	38	1.85	47	200	14	7	178	28	.83	1.23

Construction

Tube: SBFW - Natural PFA tube

SBFB - Black Static-dissipative PFA tube

Reinforcement: bonded wire braid - silicone - textile braided composite with 316 Stainless Steel braid

Operating Parameters

Temperature Range:

-65°F to +325°F (-54°C to +163°C)

Min. Burst Pressure is 4x Max. Working Pressure at 72°F (23°C)

All ratings based on 72°F/23°C

Fittings

PAGE Series - page 30

Complete line of standard PPIH crimp fittings

Notes

Factory-made assemblies only

SBFB - Special order only

Available with white silicone jacket

See page 5 for part numbering system

All dimensions nominal - Working pressures and vacuum ratings may vary depending upon end connections and process and temperature parameters.

SCW/SCB - Convuluted PTFE Hose

316 Stainless Steel Braid



Features

- High temperature hose
- Excellent corrosion resistance
- Seamless
- Open pitch
- Self draining
- Withstands extreme flexing
- Environmentally safe; low effusion
- Long life expectancy

Compliances

- FDA 21 CFR 177.1550
- USP Class VI
- ISO 10993 Sections 5, 6, 10, 11

Applications/Markets



- Fluid handling
- Chemical transfer
- Semiconductor
- Paint

Part Number		Nominal I.D.		Nominal O.D.		Maximum Working Pressure 72°F/ 23°C		Minimum Bend Radius		Vac. Rating Hg./72°F	Weight		Permanent Fitting Series
#	#	⊙		⊙		↗		↘		U	lbs	kg	⊙
Natural	Conductive	inch	mm	inch	mm	psi	bar	inch	mm	inch	lbs./ft.	kg./mtr.	
04-SCW	04-SCB	1/4	6	.46	12	1,500	104	3/4	19	28	.08	.11	PAGE
06-SCW	06-SCB	3/8	10	.54	14	1,500	104	1	25	28	.14	.21	PAGE
08-SCW	08-SCB	1/2	13	.72	18	1,500	104	1-1/2	38	28	.16	.23	PAGE
12-SCW	12-SCB	3/4	19	1.02	26	1,200	83	2	51	28	.27	.40	PAGE
16-SCW	16-SCB	1	25	1.31	33	1,000	69	2-1/2	64	28	.37	.55	PAGE
20-SCW	20-SCB	1-1/4	32	1.73	44	750	52	3	76	28	.46	.68	PAGE
24-SCW	24-SCB	1-1/2	38	1.93	49	650	45	3-3/4	95	28	.55	.81	PAGE
32-SCW	32-SCB	2	51	2.42	62	450	31	4-3/4	121	28	.90	1.4	PAGE

Construction

Tube: SCW - Natural FDA Compliant PTFE
 SCB - Black Static-Dissipative PTFE
 Reinforcement: 316 Stainless Steel braid

Operating Parameters

Temperature Range:
 -100°F to +500°F (-73°C to +260°C)
 Min. Burst Pressure is 4x Max. Working Pressure at 72°F (23°C)
 All ratings based on 72°F/23°C

Fittings

PAGE Series - page 30
 Uses crimp collar SC300 - page 38

Notes

Not suggested for steam-cold water cycling applications
 See page 5 for part numbering system
 Cannot be used with 90 or 91N series fittings

All dimensions nominal - Working pressures and vacuum ratings may vary depending upon end connections and process and temperature parameters.



PCW/PCB - Convoluted PTFE Hose

Polypropylene Braid

Convoluted



Features

- Personal handling safety
- Excellent corrosion resistance
- Seamless
- Open pitch
- Self draining
- Withstands extreme flexing
- Environmentally safe; low effusion
- Long life expectancy

Compliances

- FDA 21 CFR 177.1550
- USP Class VI
- ISO 10993 Sections 5, 6, 10, 11

Applications/Markets



- Fluid handling
- Chemical transfer
- Paint

Part Number		Nominal I.D.		Nominal O.D.		Maximum Working Pressure 72°F/ 23°C		Minimum Bend Radius		Vac. Rating Hg./72°F	Weight		Permanent Fitting Series
#	#												
Natural	Conductive	inch	mm	inch	mm	psi	bar	inch	mm	inch	lbs./ft.	kg./mtr.	
04-PCW	04-PCB	1/4	6	.55	14	350	59	3/4	19	28	.03	.05	PAGE
06-PCW	06-PCB	3/8	10	.64	16	350	59	1	25	28	.06	.09	PAGE
08-PCW	08-PCB	1/2	13	.84	21	300	21	1-1/2	38	28	.15	.22	PAGE
12-PCW	12-PCB	3/4	19	1.15	29	250	17	2	51	28	.18	.27	PAGE
16-PCW	16-PCB	1	25	1.50	38	250	17	2-1/2	64	28	.26	.39	PAGE
20-PCW	20-PCB	1-1/4	32	1.92	49	200	14	3	76	28	.37	.55	PAGE
24-PCW	24-PCB	1-1/2	38	2.12	54	200	14	3-3/4	95	28	.42	.63	PAGE
32-PCW	32-PCB	2	51	2.65	67	200	14	4-3/4	121	28	.56	.83	PAGE

Construction

Tube: PCW - Natural FDA Compliant PTFE

PCB - Black Static-Dissipative PTFE

Reinforcement: Polypropylene

Operating Parameters

Temperature Range:

0°F to +212°F (-18°C to +100°C)

Min. Burst Pressure is 4x Max. Working Pressure at 72°F (23°C)

All ratings based on 72°F/23°C

Fittings

PAGE Series - page 30

Uses crimp collar SC300 - page 38

Notes

Not suggested for steam-cold water cycling applications

See page 5 for part numbering system

Cannot be used with 90 or 91N series fittings

All dimensions nominal - Working pressures and vacuum ratings may vary depending upon end connections and process and temperature parameters.

NCW/NCB

Seamless Convuluted PTFE with Nomex Braid



Features

- Very light weight
- Superior flexibility
- Kink and vacuum resistant
- Eliminates RFI issues
- Factory assembly only

Compliances

- FDA 21 CFR 177.1550
- USP Class VI
- ISO 10993 Sections 5, 6, 10, 11

Applications/Markets



- Food & Beverage
- Pharmaceutical
- Fluid handling
- Chemical transfer
- Cosmetics
- Paint

Specialty

Part Number		Order Size	Nominal I.D.		Nominal O.D.		Maximum Working Pressure 72°F/23°C		Minimum Bend Radius		Vac. Rating Hg./72°F	Weight	
#	#												
Natural	Conductive		inch	mm	inch	mm	psi	bar	inch	mm	inch	lbs./ft.	kg./mtr.
04-NCW	04-NCB	1/4	.460	7	.460	12	725	50	1	25	30	.02	.03
06-NCW	06-NCB	3/8	.370	9	.560	14	400	28	1-1/2	38	30	.06	.09
08-NCW	08-NCB	1/2	.500	13	.740	19	280	19	2	51	30	.08	.12
12-NCW	12-NCB	3/4	.750	19	1.010	26	200	14	2-1/2	64	30	.14	.22
16-NCW	16-NCB	1	1.000	25	1.290	33	200	14	4	102	30	.22	.32

Construction

Tube: NCW - Natural PTFE tube
 NCB - Black Static Dissipative PTFE tube
 Reinforcement: Nomex braid

Fittings

PAGE Series – page 30
 Uses crimp collar SC300 - page 38

Operating Parameters

Temperature Range:
 -100°F to +400°F (-73°C to +204°C)
 Min. Burst Pressure is 4x Max. Working Pressure at 72°F (23°C)
 All ratings based on 72°F/23°C

Notes

Factory-made assemblies only
 NCB Conductive (Static Dissipative) tube I.D. surface only
 NCB Conductive Spec - Must conduct 20 microamps 1000 VDC potential 14" sample
 See page 5 for part numbering system

All dimensions nominal - Working pressures and vacuum ratings may vary depending upon end connections and process and temperature parameters.



SCWV/SCBV

Stainless Steel Braid, Heavy Wall Convoluted PTFE Hose

Convuluted



Features

- High temperature hose
- Open pitch
- Thicker wall
- Handles vacuum applications at elevated temperatures
- Excellent chemical compatibility
- Easy Cleaning, Non Adhesive

Compliances

- FDA 21 CFR 177.1550
- USP Class VI
- ISO 10993 Sections 5, 6, 10, 11

Applications/Markets



- Fluid handling
- Chemical transfer
- Semiconductor
- Paint

Part Number		Nominal I.D.		Nominal O.D.		Maximum Working Pressure 72°F/ 23°C		Minimum Bend Radius		Vac. Rating Hg./72°F	Weight		Permanent Fitting Series
#	#												
Natural	Conductive	inch	mm	inch	mm	psi	bar	inch	mm	inch	lbs./ft.	kg./mtr.	
08-SCWV	08-SCBV	1/2	13	.75	19	1,500	104	2	51	28	.17	.26	PAGE
12-SCWV	12-SCBV	3/4	19	1.04	26	1,200	83	2-3/4	70	28	.33	.49	PAGE
16-SCWV	16-SCBV	1	25	1.25	32	1,000	69	4	102	28	.37	.55	PAGE
20-SCWV	20-SCBV	1-1/4	32	1.66	42	750	52	5-1/2	140	28	.56	.83	PAGE
24-SCWV	24-SCBV	1-1/2	38	1.92	49	650	45	7	178	28	.64	.95	PAGE
32-SCWV	32-SCBV	2	51	2.49	63	450	31	8-1/2	216	28	.84	1.24	PAGE
40-SCWV	40-SCBV	2-1/2	64	3.25	83	200	14	12	305	28	1.52	2.26	PAGE
48-SCWV	48-SCBV	3	76	3.80	97	175	12	14	356	28	1.82	2.71	PAGE
64-SCWV	64-SCBV	4	102	4.76	121	150	10	16	406	28	2.10	3.13	PAGE

Construction

Tube: SCWV - Heavy Wall Natural FDA Compliant PTFE

SCBV - Heavy Wall Black Static-dissipative PTFE

Reinforcement: 316 Stainless Steel braid

Operating Parameters

Temperature Range:

-100°F to +500°F (-73°C to +260°C)

Min. Burst Pressure is 4x Max. Working Pressure at 72°F (23°C)

All ratings based on 72°F/23°C

Fittings

PAGE Series – page 30

Uses crimp collar SC300 - page 38

Notes

Factory-made assemblies only

Not suggested for steam-cold water cycling applications

See page 5 for part numbering system

Cannot be used with 90 or 91N series fittings

Vacuum wire recommended for 2-1/2, 3 and 4 inch

All dimensions nominal - Working pressures and vacuum ratings may vary depending upon end connections and process and temperature parameters.

PCWV/PCBV

Polypropylene Braid, Heavy Wall Convoluted PTFE Hose



Features

- Personal handling safety
- Open pitch
- Thicker wall
- Handles vacuum applications at elevated temperatures
- Excellent chemical compatibility
- Easy Cleaning, Non Adhesive

Compliances

- FDA 21 CFR 177.1550
- USP Class VI
- ISO 10993 Sections 5, 6, 10, 11

Applications/Markets



- Fluid handling
- Chemical transfer
- Paint

Part Number		Nominal I.D.		Nominal O.D.		Maximum Working Pressure 72°F/ 23°C		Minimum Bend Radius		Vac. Rating Hg./72°F	Weight		Permanent Fitting Series
#	#												
Natural	Conductive	inch	mm	inch	mm	psi	bar	inch	mm	inch	lbs./ft.	kg./mtr.	
08-PCWV	08-PCBV	1/2	13	.81	21	300	21	3	76	28	.14	.20	PAGE
12-PCWV	12-PCBV	3/4	19	1.30	33	250	17	3-1/2	89	28	.22	.32	PAGE
16-PCWV	16-PCBV	1	25	1.44	36	250	17	4-1/2	114	28	.32	.47	PAGE
20-PCWV	20-PCBV	1-1/4	32	1.86	47	200	14	5	127	28	.40	.59	PAGE
24-PCWV	24-PCBV	1-1/2	38	2.10	53	200	14	6	152	28	.49	.73	PAGE
32-PCWV	32-PCBV	2	51	2.66	68	200	14	8-1/2	216	28	.66	.99	PAGE
40-PCWV	40-PCBV	2-1/2	64	3.57	91	150	10	12	305	28	1.21	1.80	PAGE
48-PCWV	48-PCBV	3	76	3.92	100	125	9	14	356	28	1.45	2.16	PAGE
64-PCWV	64-PCBV	4	102	4.92	125	100	7	16	406	28	1.68	2.50	PAGE

Construction

Tube: PCWV - Heavy Wall Natural FDA Compliant PTFE

PCBV - Heavy Wall Black Static-dissipative PTFE

Reinforcement: Polypropylene

Operating Parameters

Temperature Range:

0°F to +212°F (-18°C to +100°C)

Min. Burst Pressure is 4x Max. Working Pressure at 72°F (23°C)

All ratings based on 72°F/23°C

Fittings

PAGE Series - page 30

Uses crimp collar SC300 - page 38

Notes

Factory-made assemblies only

Not suggested for steam-cold water cycling applications

See page 5 for part numbering system

Cannot be used with 90 or 91N series fittings

Vacuum wire recommended for 2-1/2, 3 and 4 inch

All dimensions nominal - Working pressures and vacuum ratings may vary depending upon end connections and process and temperature parameters.



SCWV-FS/SCBV-FS - Flare-Seal®

Stainless Steel Braid



Features

- Flare Seal fitting - Continuous PTFE through fitting; no area for bacterial entrapment
- Increased flow
- Thicker wall
- Excellent chemical compatibility
- Easy Cleaning, Non Adhesive

Compliances

- FDA 21 CFR 177.1550
- USP Class VI
- ISO 10993 Sections 5, 6, 10, 11

Applications/Markets



- Fluid handling
- Chemical transfer
- Paint
- Pharmaceutical
- Food & Beverage

Part Number		Nominal I.D.		Nominal O.D.		Maximum Working Pressure 72°F / 23°C		Minimum Bend Radius		Vac. Rating Hg./72°F	Weight	
#	#											
Natural	Conductive	inch	mm	inch	mm	psi	bar	inch	mm	inch	lbs./ft.	kg./mtr.
08-SCWV-FS	08-SCBV-FS	1/2	13	.75	19	500	35	2	51	28	.17	.26
12-SCWV-FS	12-SCBV-FS	3/4	19	1.04	26	425	29	2-3/4	70	28	.33	.49
16-SCWV-FS	16-SCBV-FS	1	25	1.25	32	350	24	4	102	28	.37	.55
20-SCWV-FS	20-SCBV-FS	1-1/4	32	1.66	42	325	22	5-1/2	140	28	.56	.83
24-SCWV-FS	24-SCBV-FS	1-1/2	38	1.92	49	300	21	7	178	28	.64	.95
32-SCWV-FS	32-SCBV-FS	2	51	2.49	63	250	17	8-1/2	216	28	.84	1.24
40-SCWV-FS	40-SCBV-FS	2-1/2	64	3.25	83	200	14	12	305	28	1.52	2.26
48-SCWV-FS	48-SCBV-FS	3	76	3.80	97	175	12	14	356	28	1.82	2.71
64-SCWV-FS	64-SCBV-FS	4	102	4.76	121	150	10	16	406	28	2.10	3.13

Construction

Tube: SCWV-FS- Heavy Wall Natural FDA Compliant PTFE
 SCBV-FS - Heavy Wall Black Static-dissipative PTFE
 Reinforcement: 316 Stainless Steel braid

Operating Parameters

Temperature Range:
 -100°F to +500°F (-73°C to +260°C)
 Min. Burst Pressure is 4x Max. Working Pressure at 72°F (23°C)
 All ratings based on 72°F/23°C

Fittings

PAGE Series – page 30

Notes

Factory-made assemblies only
 Not suggested for steam-cold water cycling applications
 All dimensions nominal
 See page 5 for part numbering system
 Cannot be used with 90 or 91N series fittings

All dimensions nominal - Working pressures and vacuum ratings may vary depending upon end connections and process and temperature parameters.

PCWV-FS/PCBV-FS - Flare-Seal®

Polypropylene Braid



Features

- Flare Seal fitting - Continuous PTFE through fitting; no area for bacterial entrapment
- Increased flow
- Personal handling safety
- Good chemical compatibility
- Easy Cleaning, Non Adhesive

Compliances

- FDA 21 CFR 177.1550
- USP Class VI
- ISO 10993 Sections 5, 6, 10, 11

Flare-Seal

Applications/Markets



- Fluid handling
- Chemical transfer
- Paint
- Pharmaceutical
- Food & Beverage

Part Number		Nominal I.D.		Nominal O.D.		Maximum Working Pressure 72°F / 23°C		Minimum Bend Radius		Vac. Rating Hg./72°F	Weight	
#	#	⊙		⊙		↗		↘		U	lbs	kg
Natural	Conductive	inch	mm	inch	mm	psi	bar	inch	mm	inch	lbs./ft.	kg./mtr.
08-PCWV-FS	08-PCBV-FS	1/2	13	.810	21	300	21	3	76	28	.14	.20
12-PCWV-FS	12-PCBV-FS	3/4	19	1.10	28	250	17	3-1/2	89	28	.22	.32
16-PCWV-FS	16-PCBV-FS	1	25	1.44	36	250	17	4-1/2	114	28	.31	.47
20-PCWV-FS	20-PCBV-FS	1-1/4	32	1.86	47	200	14	5	127	28	.40	.59
24-PCWV-FS	24-PCBV-FS	1-1/2	38	2.10	53	200	14	6	152	28	.49	.73
32-PCWV-FS	32-PCBV-FS	2	51	2.66	68	200	14	8-1/2	216	28	.66	.99
40-PCWV-FS	40-PCBV-FS	2-1/2	64	3.42	87	150	10	12	305	28	1.21	1.80
48-PCWV-FS	48-PCBV-FS	3	76	3.92	100	125	9	14	356	28	1.45	2.16
64-PCWV-FS	64-PCBV-FS	4	102	4.92	125	100	7	16	406	28	1.68	2.50

Construction

Tube: PCWV-FS - Heavy Wall Natural FDA Compliant PTFE

PCBV-FS- Heavy Wall Black Static-dissipative PTFE

Reinforcement: Polypropylene

Operating Parameters

Temperature Range:

0°F to +212°F (-18°C to +100°C)

Min. Burst Pressure is 4x Max. Working Pressure at 72°F (23°C)

All ratings based on 72°F/23°C

Fittings

PAGE Series - page 30

Notes

Factory-made assemblies only

Not suggested for steam-cold water cycling applications

See page 5 for part numbering system

Cannot be used with 90 or 91N series fittings

All dimensions nominal - Working pressures and vacuum ratings may vary depending upon end connections and process and temperature parameters.



SBP

Platinum Cured Braided Silicone Tubing



Features

- Easy Cleaning
- Insulates hose for safer operator handling
- Good chemical compatibility
- Non Adhesive

Compliances

- FDA 21 CFR 177.2600
- USP Class VI
- ISO 10993 Sections 5, 6, 10, 11
- USDA Standards
- 3A Standards

Silicone

Applications/Markets



- Fluid handling
- Pharmaceutical
- Food & Beverage

Part Number	Nominal I.D.		Nominal O.D.		Maximum Working Pressure 68°F/20°C		Minimum Burst Pressure 68°F/20°C		Length/Roll		Weight		Permanent Fitting Series
	#												
	inch	mm	inch	mm	psi	bar	psi	bar	feet	meter	lbs./ft.	kg./mtr.	
04-SBP	.250	6	.500	13	160	11.7	575	40	50	15.2	.112	.167	PAGE
06-SBP	.375	10	.625	16	150	10.3	550	38	50	15.2	.117	.174	PAGE
08-SBP	.500	13	.875	22	140	9.7	420	29	50	15.2	.190	.283	PAGE
12-SBP	.750	19	1.125	29	100	6.9	350	24	50	15.2	.326	.486	PAGE
16-SBP	1.000	25	1.405	36	60	4.1	225	16	50	15.2	.404	.602	PAGE

Construction

Tube: Platinum cured silicone

Reinforcement: Textile braid

Jacket: Platinum cured silicone

Operating Parameters

Temperature Range:

-80°F to +450°F (-62°C to +232°C)

Min. Burst Pressure is 4x Max. Working Pressure at 68°F (20°C)

All ratings based on 68°F (20°C)

Working pressures may vary depending upon end connections and process and temperature parameters.

Fittings

PAGE Series – page 30

Uses crimp collar SIL300 - page 38

Cannot be used with 90 or 91N/91 series fittings

Notes

Available with double braid

See page 7 for part numbering system

All dimensions nominal - Working pressures and vacuum ratings may vary depending upon end connections and process and temperature parameters.

SWPV

Platinum Cured 4 Ply Silicone with Stainless Steel Wire Helix



Features

- Easy Cleaning
- Insulates hose for safer operator handling
- Good chemical compatibility
- Non Adhesive

Compliances

- FDA 21 CFR 177.2600
- **USP Class VI Certified**
- ISO 10993 Sections 5, 6, 10, 11
- USDA Standards
- 3A Standards

Applications/Markets



- Fluid handling
- Pharmaceutical
- Food & Beverage

Silicone

Part Number	Nominal I.D.		Nominal O.D.		Maximum Working Pressure 72°F/23°C		Minimum Burst Pressure 72°F/23°C		Vac. Rating Hg./72°F	Minimum Bend Radius			Weight		Permanent Fitting Series
	#	inch	mm	inch	mm	psi	bar	psi		bar	inch	inch	mm	lbs./ft.	
08-SWPV	.500	13	.900	23	250	17	750	52	30	1-1/2	38	.27	.40	PAGE	
12-SWPV	.750	19	1.150	29	250	17	750	52	30	2-1/2	64	.37	.55	PAGE	
16-SWPV	1.000	25	1.400	36	250	17	750	52	30	3	76	.46	.69	PAGE	
24-SWPV	1.500	38	1.900	48	250	17	750	52	30	4	102	.66	.98	PAGE	
32-SWPV	2.000	51	2.400	61	230	16	700	48	30	5-1/2	140	.85	1.27	PAGE	

Construction

Tube: Platinum cured silicone
 Reinforcement: Wrapped textile with Stainless Steel wire helix
 Jacket: Platinum cured silicone

Operating Parameters

Temperature Range:
 -80°F to +450°F (-62°C to +232°C)
 Min. Burst Pressure is 4x Max. Working Pressure at 72°F (23°C)
 All ratings based on 72°F/23°C

Working pressures may vary depending upon end connections and process and temperature parameters.

Fittings

PAGE Series - page 30
 Uses crimp collar SIL300 - page 38
 Cannot be used with 90 or 91N/91 series fittings

Notes

Available with double braid
 See page 7 for part numbering system

All dimensions nominal - Working pressures and vacuum ratings may vary depending upon end connections and process and temperature parameters.



RCTW/RCTB EPDM Rubber Covered Fluoropolymer Hose



Features

- Personal handling safety
- Handles full vacuum
- Good chemical compatibility
- Easy Cleaning, Non Adhesive

Compliances

- FDA 21 CFR 177.1550 (FEP core tube)
- **USP Class VI Certified**
- ISO 10993 Sections 5, 6, 10, 11

Applications/Markets



- Food & Beverage
- Pharmaceutical
- Fluid handling
- Chemical
- Industrial
- Paint
- Semiconductor

Specialty

Part Number		Nominal I.D.		Nominal O.D.		Maximum Working Pressure 72°F / 23°C		Minimum Bend Radius		Vac. Rating Hg./72°F	Weight		Permanent Fitting Series
#	#	⊙		⊙		⌚		↷		U	lbs	kg	⊗
Natural	Conductive	inch	mm	inch	mm	psi	bar	inch	mm	inch	lbs./ft.	kg./mtr.	
08-RCTW	08-RCTB	1/2	13	.95	24	500	35	2-1/2	64	30	.33	.49	PAGE
12-RCTW	12-RCTB	3/4	19	1.25	32	500	35	3	76	30	.51	.76	PAGE
16-RCTW	16-RCTB	1	25	1.53	39	450	31	4	102	30	.67	1.00	PAGE
20-RCTW	20-RCTB	1-1/4	32	1.74	44	375	26	7	178	30	.72	1.07	PAGE
24-RCTW	24-RCTB	1-1/2	38	2.13	54	375	26	9	229	30	1.10	1.51	PAGE
32-RCTW	32-RCTB	2	51	2.68	68	300	21	10-1/2	267	30	1.54	2.30	PAGE
40-RCTW	40-RCTB	2-1/2	64	3.30	84	200	14	15	381	30	2.07	3.09	PAGE
48-RCTW	48-RCTB	3	76	3.88	99	200	14	18	457	30	2.99	4.46	PAGE
64-RCTW	64-RCTB	4	102	4.98	127	150	10	22-1/2	572	30	4.33	6.46	PAGE

Construction

Tube: RCTW - Natural FEP tube

RCTB - Static-dissipative PFA tube

Reinforcement: Double wire helix - multi layered rubber

Cover: Textile reinforced EPDM

Operating Parameters

Temperature Range:

-40°F to +300°F (-40°C to +149°C) Decrease working pressure one percent for every 2°F above 212°F.

Operating pressures shown are for non-impulse service

All ratings based on 72°F/23°C

Fittings

PAGE Series - page 30

Uses crimp collar RC300 - page 38

Notes

RCTB - Special order only

See page 5 for part numbering system

Cannot be used with 90 or 91N series fittings

All dimensions nominal - Working pressures and vacuum ratings may vary depending upon end connections and process and temperature parameters.

CWV/CBV

Fluoropolymer Convuluted Tubing



Features

- Open pitched
- Self draining
- Very flexible
- Multiple cuffing options

Compliances

- FDA 21 CFR 177.1550
- USP Class VI
- ISO 10993 Sections 5, 6, 10, 11

Applications/Markets



- Food & Beverage
- Pharmaceutical
- Fluid handling
- Chemical
- Industrial
- Paint
- Semiconductor

Part Number		Order Size	Nominal I.D.		Maximum O.D.		Maximum Working Pressure 72°F/23°C		Minimum Burst Pressure 72°F/23°C		Minimum Bend Radius		Vac. Rating Hg./72°F	Weight	
#	#														
Natural	Conductive	inch	inch	mm	inch	mm	psi	bar	psi	bar	inch	mm	inch	lbs./ft.	kg./mtr.
08-CWV	08-CBV	1/2	.46	12	.700	18	50	3.4	100	6.9	1-1/2	38	30	.09	.13
12-CWV	12-CBV	3/4	.69	18	1.01	26	50	3.4	100	6.9	1-7/8	48	30	.17	.25
16-CWV	16-CBV	1	.85	22	1.51	31	50	3.4	100	6.9	2-1/2	64	30	.18	.27
20-CWV	20-CBV	1-1/4	1.14	29	1.61	41	40	2.8	80	5.5	3-1/8	79	30	.28	.42
24-CWV	24-CBV	1-1/2	1.45	37	1.88	48	40	2.8	80	5.5	3-3/4	95	30	.32	.48
32-CWV	32-CBV	2	1.80	46	2.43	62	30	2.0	60	4.1	4-3/4	120	30	.62	.76
40-CWV	40-CBV	2-1/2	2.50	64	3.21	82	20	1.4	40	2.8	5	127	30	.76	1.13
48-CWV	48-CBV	3	3.00	76	3.75	95	15	1.0	30	2.0	7	178	30	.91	1.35
64-CWV	64-CBV	4	4.00	102	4.75	121	10	0.7	20	1.3	9	229	30	1.05	1.56

Construction

Tube: CWV: FDA Compliant PTFE
 CBV: Black Static Dissipative PTFE

Fittings

PAGE Series – page 30
 Uses crimp collar SC300 - page 38

Operating Parameters

Temperature Range:
 -100°F to +500°F (-73°C to +260°C)

Notes

Bend Radius based on 36" length piece

All dimensions nominal - Working pressures and vacuum ratings may vary depending upon end connections and process and temperature parameters.

Specialty

Crimp Fittings

Two Piece - 316 Stainless Steel

PAGE Series True Bore Fittings

Works on the following hose types:

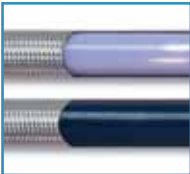

Smooth True Bore



Rubber Covered
Fluoropolymer

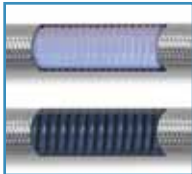

Convuluted SS Braid

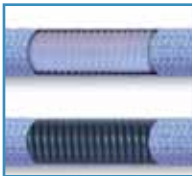

Convuluted
Non-Metallic Braid



Silicone Hose &
Tubing

Where applicable, “B” indicates Brass and “C” indicates Carbon Steel and “S” indicates Stainless Steel. For detailed ordering information, contact Customer Service.

Features

- New fitting part numbers follow Parker standard nomenclature
- Fittings are interchangeable between styles
 - reduces inventory

Options

- Application specific designs available
- Stainless or Carbon Steel

PAGE Fitting Nomenclature

Example: 08-16SAN-S

This example describes a permanent sanitary flange step down, 1/2" I.D. hose with a 1" sanitary flange. This fitting is constructed of stainless steel since the designated material is -S.

08-16SAN-S – **Hose I.D.** (1/2")

08-16SAN-S – **End Size** (1")

08-16SAN-S – **End Configuration Code**
(Sanitary Flange)

08-16SAN-S – **PAGE Fitting Material Selection**

- B = All Brass
- C = Carbon Steel
- S = Stainless Steel

Crimp Fittings

Sanitary Sizing

Typical Dimensions for Sanitary Fittings

These actual size drawings are provided to eliminate sizing errors when specifying sanitary fittings. The outside diameter is the same for 1/8", 1/4", 3/8", 1/2" and the 3/4" (mini) styles. For your convenience and ordering accuracy, all of these drawings may be used as sizing I.D. and O.D. patterns. These fittings are ASME-BPE compliant.

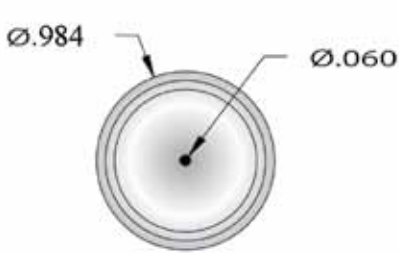

1/8" MINI T.C.

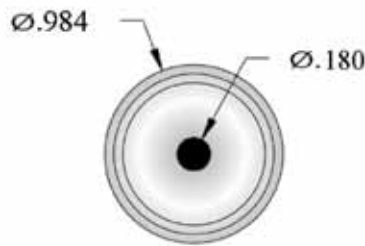

1/4" MINI T.C.

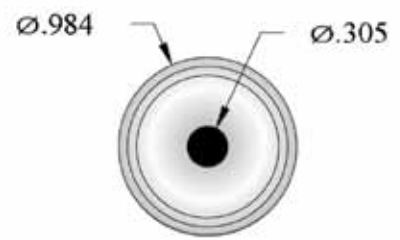

3/8" MINI T.C.

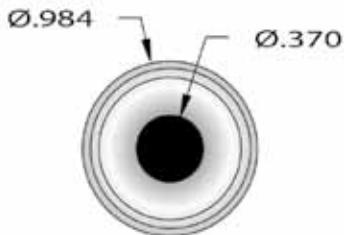

1/2" MINI T.C.

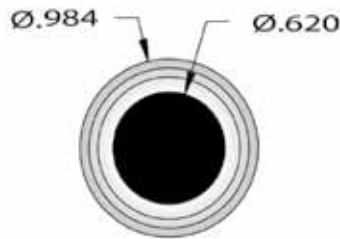

3/4" MINI T.C.

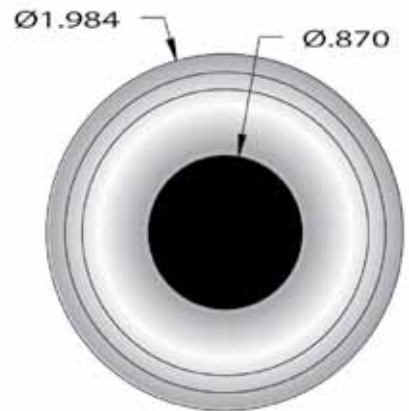

1" T.C.

Crimp Fittings

Sanitary Sizing

Typical Dimensions for Sanitary Fittings

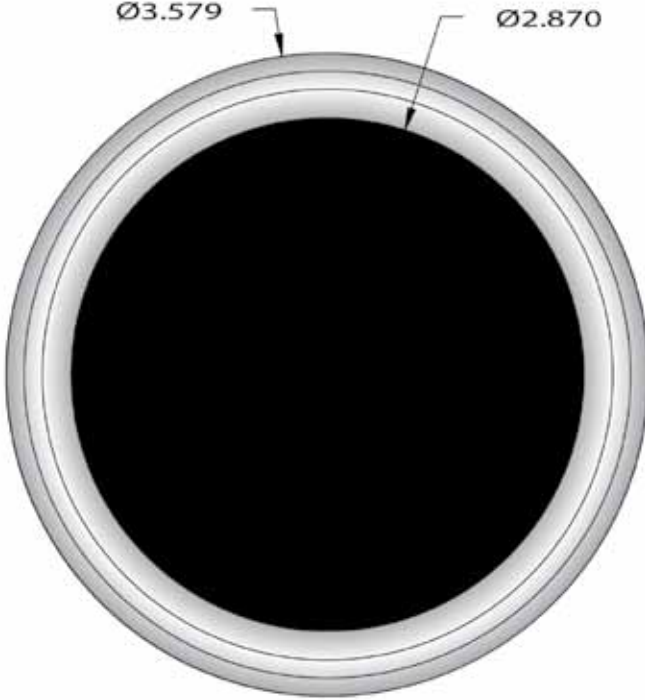
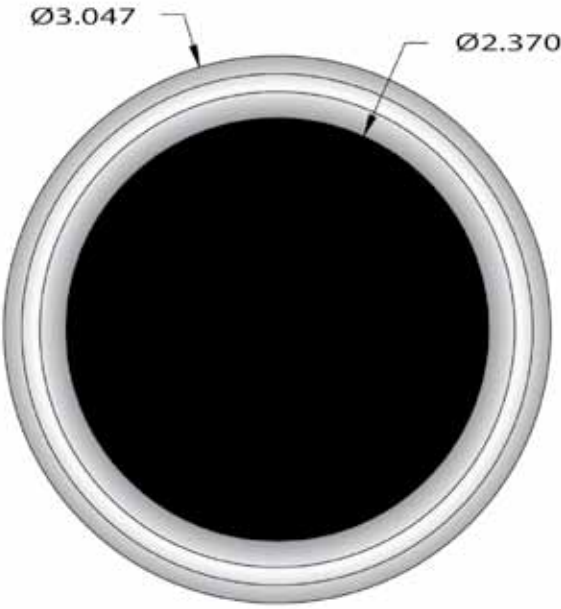
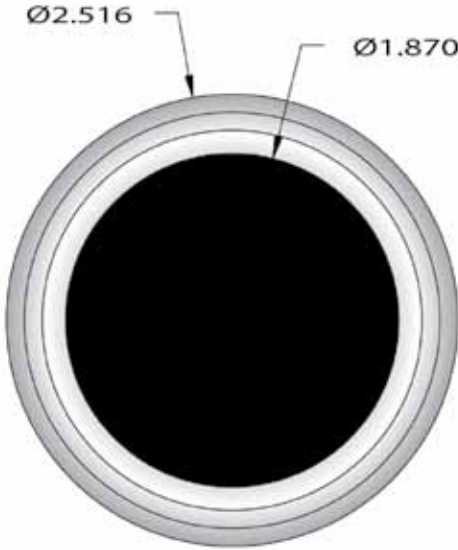
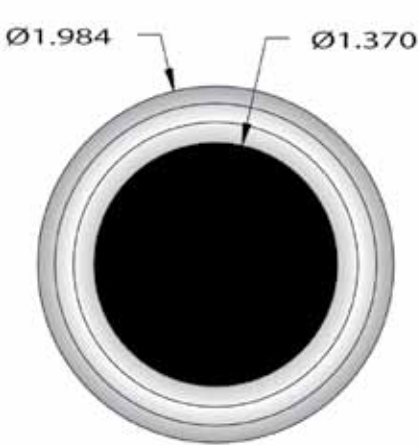

PAGE Series
Fittings

PAGE Fittings Visual Index

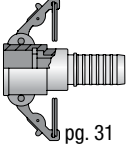
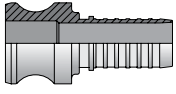
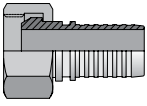
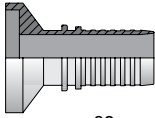
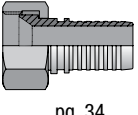
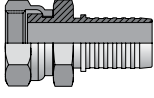
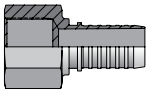
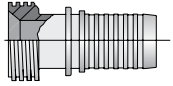
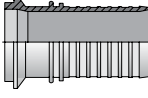
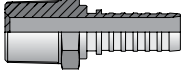
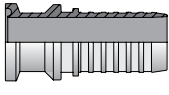
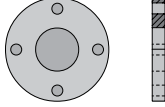
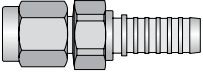
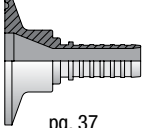
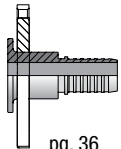
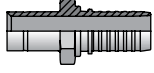
PAGE Fittings PERMANENT	CL-S Female Cam & Groove  pg. 31	E-S Male Cam & Groove  pg. 31	FBS-S Female Sanitary Bevel Seat  pg. 31	FIL-S Female I-Line® Sanitary  pg. 32	FJX-S Female JIC 37° Swivel  pg. 34
	FORFS-S Female Seal-Lok™ Swivel Short  pg. 34	FP-S Female NPTF Pipe Rigid  pg. 33	MBS-S Male Sanitary Bevel Seat  pg. 32	MIL-S Male I-Line® Sanitary  pg. 32	MP-S Male NPTF Pipe Rigid  pg. 33
	MSAN-S Mini Sanitary Flange  pg. 37	PF ANSI Flange  pg. 36	PLCF-S Female A-Lok® Compression  pg. 35	SAN-S Sanitary Flange & Step Downs  pg. 37	SFR-S Flange Retainer  pg. 36
	TUBE-S A-Lok® Male Stand Pipe-Rigid "V" Notch  pg. 35	<p>NOTE:</p> <p>The PAGE fitting call-out does not follow traditional Parker fitting nomenclature. The end size and hose size are reversed.</p> <p>Length calculations for PAGE hose assemblies are typically made sealing surface to sealing surface per the NAHAD Fluoropolymer Hose Assembly Specification Guidelines unless otherwise requested by customer at time of order.</p>			

CL-S Female Cam & Groove

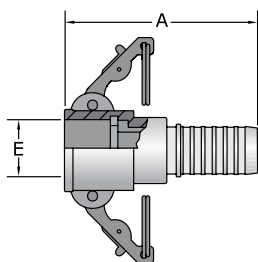

Part Number	Hose I.D.		A		E	
	inch	mm	inch	mm	inch	mm
#	○					
16-16CL-S	1	25	4.2	107	1.44	37
24-24CL-S	1-1/2	38	5.2	132	2.10	53
32-32CL-S	2	51	6.0	152	2.48	63
48-48CL-S	3	76	7.2	183	3.60	91
64-64CL-S	4	102	7.8	198	4.70	119

Construction: Stainless Steel.

Note: Also available as encapsulated female cam under part number TEC-S and TECL-S.

E-S Male Cam & Groove

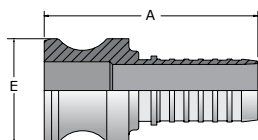

Part Number	Hose I.D.		A		E	
	inch	mm	inch	mm	inch	mm
#	○					
12-12E-S	3/4	19	2.60	66	1.26	32
16-16E-S	1	25	2.91	74	1.44	37
20-20E-S	1-1/4	32	3.64	93	1.78	45
24-24E-S	1-1/2	38	4.03	102	2.10	53
32-32E-S	2	51	4.75	121	2.48	63
48-48E-S	3	76	5.75	146	3.60	91
64-64E-S	4	102	5.88	149	4.70	119

Construction: Stainless Steel.

FBS-S Female Sanitary Bevel Seat

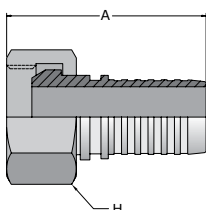

Part Number	Acme Thread	Hose I.D.		A	
		inch	mm	inch	mm
#		○			
16-16FBS-S	1-1/2-8	1	25	2.74	70
24-24FBS-S	2-8	1-1/2	38	3.41	87
32-32FBS-S	2-1/2-8	2	51	3.94	100
40-40FBS-S	3-8	2-1/2	64	4.37	110
48-48FBS-S	3-1/2-8	3	76	4.85	123
64-64FBS-S	4-5/8-6	4	102	5.24	133

Construction: Stainless Steel.

NOTE: The PAGE fitting call-out does not follow traditional Parker fitting nomenclature. The end size and hose size are reversed. Length calculations for PAGE hose assemblies are typically made sealing surface to sealing surface per the NAHAD Fluoropolymer Hose Assembly Specification Guidelines unless otherwise requested by customer at time of order.

MBS-S Male Sanitary Bevel Seat

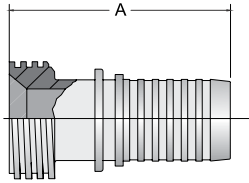

Part Number	Acme Thread	Hose I.D.		A	
		inch	mm	inch	mm
#					
16-16MBS-S	1-1/2-8	1	25	2.74	70
24-24MBS-S	2-8	1-1/2	38	3.41	87
32-32MBS-S	2-1/2-8	2	51	3.94	100
40-40MBS-S	3-8	2-1/2	64	4.37	110
48-48MBS-S	3-1/2-8	3	76	4.85	123
64-64MBS-S	4-5/8-6	4	102	5.24	133

Construction: Stainless Steel.

FIL-S Female I-Line® Sanitary

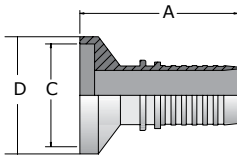

Part Number	Hose I.D.		A		Flange Size C		D	
	inch	mm	Inch	mm	Inch	mm	Inch	mm
#								
16-16FIL-S	1	25	2.60	66	1.25	32	2.00	51
24-24FIL-S	1-1/2	38	3.43	87	1.76	45	2.00	51
32-32FIL-S	2	51	4.23	107	2.26	57	2.64	67
40-40FIL-S	2-1/2	64	4.42	112	2.76	70	3.31	84
48-48FIL-S	3	76	4.84	123	3.31	84	3.87	98

Construction: Stainless Steel.

PAGE Series
Fittings

MIL-S Male I-Line® Sanitary

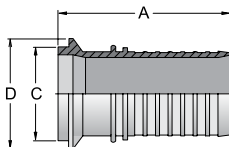

Part Number	Hose I.D.		A		Flange Size C		D	
	inch	mm	Inch	mm	Inch	mm	Inch	mm
#								
16-16MIL-S	1	13	2.60	66	1.25	32	2.00	51
24-24MIL-S	1-1/2	19	3.43	87	1.76	45	2.00	51
32-32MIL-S	2	25	4.23	107	2.26	57	2.64	67
40-40MIL-S	2-1/2	64	4.42	112	2.76	70	3.31	84
48-48MIL-S	3	76	4.84	123	3.31	84	3.87	98

Construction: Stainless Steel.

NOTE: The PAGE fitting call-out does not follow traditional Parker fitting nomenclature. The end size and hose size are reversed. Length calculations for PAGE hose assemblies are typically made sealing surface to sealing surface per the NAHAD Fluoropolymer Hose Assembly Specification Guidelines unless otherwise requested by customer at time of order.

FP-S Female NPTF Pipe-Rigid

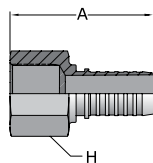

Part Number	Thread Size	Hose I.D.		A		H Hex
		inch	mm	inch	mm	inch
#						
04-04FP-S	1/4-18	1/4	6	1.63	41	3/4
06-06FP-S	3/8-18	3/8	10	1.73	44	7/8
08-08FP-S	1/2-14	1/2	13	2.25	57	1-1/16
12-12FP-S	3/4-14	3/4	19	2.60	66	1-5/16
16-16FP-S	1-11 1/2	1	25	2.85	72	1-5/8
20-20FP-S	1 1/4-11 1/2	1-1/4	32	3.50	89	2
24-24FP-S	1 1/2-11 1/2	1-1/2	38	3.63	92	2-3/8
32-32FP-S	2-11 1/2	2	51	4.25	108	2-7/8

Construction: Stainless Steel.

MP-S Male NPTF Pipe-Rigid

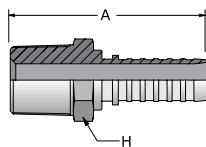

Part Number	Thread Size	Hose I.D.		A		H Hex
		inch	mm	inch	mm	inch
#						
04-04MP-S	1/4-18	1/4	6	1.63	41	9/16
06-06MP-S	3/8-18	3/8	10	1.76	45	11/16
08-08MP-S	1/2-14	1/2	13	2.34	59	7/8
12-12MP-S	3/4-14	3/4	19	2.59	66	1-1/8
16-16MP-S	1-11 1/2	1	25	3.00	76	1/3/8
20-20MP-S	1 1/4-11 1/2	1-1/4	32	3.39	86	1-3/4
24-24MP-S	1 1/2-11 1/2	1-1/2	38	3.89	99	2
32-32MP-S	2-11 1/2	2	51	4.58	116	2-1/2
40-40MP-S	2-1/2 8	2-1/2	64	5.28	134	3
48-48MP-S	3-8	3	76	5.93	151	3-3/4
64-64MP-S	4-8	4	102	6.82	173	4-5/8

Construction: Stainless Steel.

NOTE: The PAGE fitting call-out does not follow traditional Parker fitting nomenclature. The end size and hose size are reversed. Length calculations for PAGE hose assemblies are typically made sealing surface to sealing surface per the NAHAD Fluoropolymer Hose Assembly Specification Guidelines unless otherwise requested by customer at time of order.

FJX-S Female JIC 37° Swivel

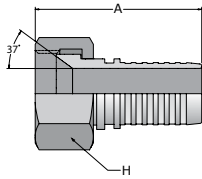

Part Number	Thread Size	Hose I.D.		A		H Hex
		inch	mm	inch	mm	inch
#						
04-04FJX-S	7/16-20	1/4	6	1.44	37	9/16
06-06FJX-S	9/16-18	3/8	10	1.65	42	11/16
08-08FJX-S	3/4-16	1/2	13	2.13	54	7/8
12-12FJX-S	1-1/16-12	3/4	19	2.54	65	1-1/4
16-16FJX-S	1-5/16-12	1	25	2.76	70	1-1/2
20-20FJX-S	1-5/8-12	1-1/4	32	3.25	83	2
24-24FJX-S	1-7/8-12	1-1/2	38	3.73	95	2-1/4
32-32FJX-S	2-1/2-12	2	51	4.55	116	2-7/8
40-40FJX-S	3-12	2-1/2	64	4.76	121	3-3/8

Construction: Stainless Steel.

FORFS-S Female Seal-Lok® Swivel-Short

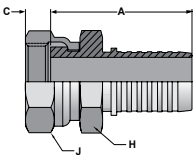

Part Number	Thread Size	Hose I.D.		A		C		H Hex	J Hex
		inch	mm	inch	mm	inch	mm	inch	inch
#									
04-04FORFS-S	9/16-18	1/4	6	1.50	38	.32	8	9/16	11/16
06-06FORFS-S	11/16-16	3/8	10	1.85	47	.32	8	11/16	13/16
08-08FORFS-S	13/16-16	1/2	13	2.00	51	.43	11	13/16	15/16
12-12FORFS-S	1-3/16-12	3/4	19	2.30	58	.57	14	1-1/8	1-3/8
16-16FORFS-S	1-7/16-12	1	25	2.50	64	.58	15	1-3/8	1-5/8
24-24FORFS-S	2-12	1-1/2	38	3.98	101	.59	15	2	2-1/4

Construction: Stainless Steel.

NOTE: When measuring overall length to the end of the nut, B+C dimensions must be used to calculate cut-off allowance. Stainless steel fittings must be assembled with Karrykrimp2, PHastkrimp, Superkrimp or Parkimp2. See CrimpSource for more information.

NOTE: The PAGE fitting call-out does not follow traditional Parker fitting nomenclature. The end size and hose size are reversed. Length calculations for PAGE hose assemblies are typically made sealing surface to sealing surface per the NAHAD Fluoropolymer Hose Assembly Specification Guidelines unless otherwise requested by customer at time of order.

PLCF-S Female A-LOK® Compression (With Nut & Ferrules)

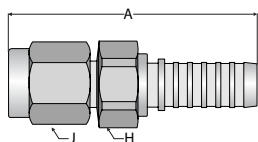

Part Number	Thread Size	Hose I.D.		A		H Hex	J Hex
		inch	mm	inch	mm	inch	inch
#							
04-04PLCF-S	7/16-20	1/4	6	1.52	39	9/16	9/16
06-06PLCF-S	9/16-20	3/8	10	1.63	41	11/16	11/16
08-08PLCF-S	3/4-20	1/2	13	2.05	52	7/8	7/8
12-12PLCF-S	1-20	3/4	19	2.30	58	1-1/8	1-1/8
16-16PLCF-S	1-5/16-20	1	25	2.57	65	1-3/8	1-1/2

Construction: Stainless Steel.

TUBE-S A-LOK® Male Standpipe-Rigid with "V" Notch

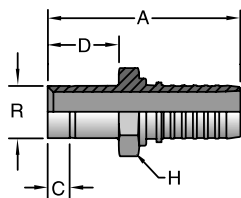

Part Number	Diameter R	Hose I.D.		A		C		D		H Hex
		inch	mm	inch	mm	inch	mm	inch	mm	inch
#										
04-04TUBE-S	1/4	1/4	6	1.75	45	.18	5	.66	17	7/16
06-06TUBE-S	3/8	3/8	10	2.06	52	.25	6	.85	2	5/8
08-08TUBE-S	1/2	1/2	13	2.56	65	.34	9	.97	25	3/4
12-12TUBE-S	3/4	3/4	19	2.86	73	.40	10	1.02	26	1-1/8
16-16TUBE-S	1	1	25	3.34	85	.52	13	1.30	33	1-3/8
20-20TUBE-S	1-1/4	1-1/4	32	4.05	10	.50	13	1.75	45	1-3/4

Construction: Stainless Steel.

NOTE: The PAGE fitting call-out does not follow traditional Parker fitting nomenclature. The end size and hose size are reversed. Length calculations for PAGE hose assemblies are typically made sealing surface to sealing surface per the NAHAD Fluoropolymer Hose Assembly Specification Guidelines unless otherwise requested by customer at time of order.

PF ANSI B16.5 Flange

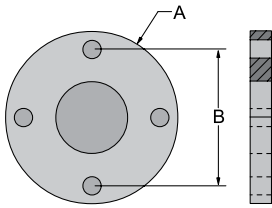

Carbon Steel (Epoxy Coated)	316 Stainless Steel	304 Stainless Steel	Flange Diameter A		Hose I.D.		Bolt Spacing B	
#	#	#	∅		⊙			
Flange	Flange	Flange	inch	mm	inch	mm	inch	mm
08-PF150	08-PF156	08-PF154	3-1/2	89	1/2	13	2-3/8	60
12-PF150	12-PF156	12-PF154	3-7/8	98	3/4	19	2-3/4	70
16-PF150	16-PF156	16-PF154	4-1/4	108	1	25	3-1/8	79
20-PF150	20-PF156	20-PF154	4-5/8	117	1-1/4	32	3-1/2	89
24-PF150	24-PF156	24-PF154	5	127	1-1/2	38	3-7/8	98
32-PF150	32-PF156	32-PF154	6	152	2	51	4-3/4	120
40-PF150	40-PF156	40-PF154	7	178	2-1/2	64	5-1/2	140
48-PF150	48-PF156	48-PF154	7-1/2	191	3	76	6	152
64-PF150	64-PF156	64-PF154	9	229	4	102	7-1/2	191

Note: Also available in 300 lb. flange and other materials. Contact Customer Service for options.

SFR-S Flange Retainer

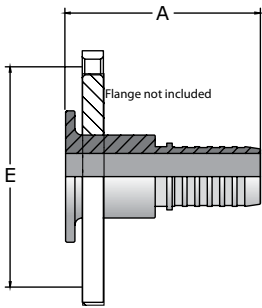

Part Number	Flange Diameter		Hose I.D.		A		Bolt Spacing E	
#	⊙		⊙					
	inch	mm	inch	mm	inch	mm	inch	mm
08-08SFR-S	3-1/2	89	1/2	13	2.30	58	2-3/8	60
12-12SFR-S	3-7/8	98	3/4	19	2.60	66	2-3/4	70
16-16SFR-S	4-1/4	108	1	25	3.00	76	3-1/8	79
20-20SFR-S	4-5/8	117	1-1/4	32	3.25	83	3-1/2	89
24-24SFR-S	5	127	1-1/2	38	3.65	93	3-7/8	98
32-32SFR-S	6	152	2	51	4.25	108	4-3/4	120
40-40SFR-S	7	178	2-1/2	64	5.00	127	5-1/2	140
48-48SFR-S	7-1/2	191	3	76	5.50	140	6	152
64-64SFR-S	9	229	4	102	7.00	178	7-3/4	197

Construction: Stainless Steel.

NOTE: The PAGE fitting call-out does not follow traditional Parker fitting nomenclature. The end size and hose size are reversed. Length calculations for PAGE hose assemblies are typically made sealing surface to sealing surface per the NAHAD Fluoropolymer Hose Assembly Specification Guidelines unless otherwise requested by customer at time of order.

MSAN-S Mini Sanitary Flange

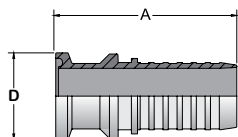

Part Number #	Hose I.D.		A		Flange Size D	
	inch	mm	inch	mm	inch	mm
04-04MSAN-S	1/4	6	1.47	37	.98	25
04-08MSAN-S	1/4	6	1.50	38	.98	25
06-06MSAN-S	3/8	10	1.53	39	.98	25
06-08MSAN-S	3/8	10	1.53	39	.98	25
06-12MSAN-S	3/8	10	1.66	42	.98	25
08-08MSAN-S	1/2	13	1.90	48	.98	25
08-12MSAN-S	1/2	13	1.94	49	.98	25
12-12MSAN-S	3/4	19	2.16	55	.98	25
16-16MSAN-S	1	25	2.27	58	.98	25

Construction: Stainless Steel.

Meets ASME-BPE-2009.

NOTE: The PAGE fitting call-out does not follow traditional Parker fitting nomenclature. The end size and hose size are reversed.

NOTE: The PAGE fitting call-out does not follow traditional Parker fitting nomenclature. The end size and hose size are reversed. Length calculations for PAGE hose assemblies are typically made sealing surface to sealing surface per the NAHAD Fluoropolymer Hose Assembly Specification Guidelines unless otherwise requested by customer at time of order.

SAN-S Sanitary Flange & Step-Downs

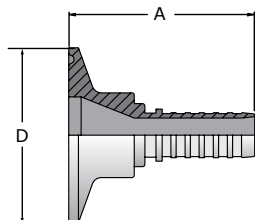

Part Number #	Hose I.D.		A		Flange Size D	
	inch	mm	inch	mm	inch	mm
08-08SAN-S	1/2	13	2.11	54	1.98	50
08-16SAN-S	1/2	13	2.11	54	1.98	50
08-24SAN-S	1/2	13	2.34	59	1.98	50
12-12SAN-S	3/4	19	2.32	59	1.98	50
16-16SAN-S	1	25	2.45	62	1.98	50
20-20SAN-S	1-1/2	38	3.10	79	1.98	50
06-24SAN-S	3/8	10	1.35	34	1.98	50
12-24SAN-S	3/4	19	2.34	59	1.98	50
16-24SAN-S	1	25	2.32	59	1.98	50
24-24SAN-S	2	51	3.10	79	2.50	64
24-32SAN-S	1-1/4	32	3.12	79	2.50	64
32-40SAN-S	2	51	3.75	95	3.00	76
32-32SAN-S	2-1/2	64	4.00	102	2.50	64
40-40SAN-S	2-1/2	64	4.00	102	3.00	76
48-48SAN-S	3	76	4.50	114	3.50	89
40-48SAN-S	2-1/2	64	4.05	103	3.50	89
64-64SAN-S	4	102	4.75	121	4.70	119
48-64SAN-S	3	76	4.20	107	4.70	119

Construction: Stainless Steel.

Meets ASME-BPE-2009.

NOTE: The PAGE fitting call-out does not follow traditional Parker fitting nomenclature. The end size and hose size are reversed.



Collars

For Hose with PAGE Series Fittings



Parker PAGE fittings are unique because the collars are designed to keep inventory at a minimum. Where possible, collars are designed to fit hoses by size rather than by hose series. This means that a 06-SC300 will work on many convoluted hoses rather than only on one specific series of hose.

By Size

Hose	Collar # Size	04	06	08	12	16	20	24	32	40	48	64
STW STB	ST300	ST300	ST300	ST300	ST300	ST300	ST300	ST300				
SCW SCB	SC300	SC300	SC300	SC300	SC300	SC300	SC300	SC300	SC300			
PCW PCB	PC300	PC300	PC300	PC300	PC300	PC300	PC300	PC300	PC300			
SCWV SCBV	SC300			SC300	SC300	SC300	SC300	SC300	SC300	SC300	SC300	SC300
PCWV PCBV	PC300			PC300	PC300	PC300	PC300	PC300	PC300	PC300	PC300	PC300
CWV CBV	SC300 ST300 ST301			ST300	ST300	ST300		ST301	SC300	SC300	SC300	
SBP	SIL300	SIL300	SIL300	SIL300	SIL300	SIL300						
SWPV	SIL300			SIL300	SIL300	SIL300		SIL300	SIL300			
SBFW SBFB	SBF300		SBF300	SBF300	SBF300	SBF300		SBF300				
RCTW RCTB	RC300			RC300	RC300	RC300	RC300	RC300	RC300	RC300	RC300	RC300
NCW NCB	SC300	SC300	SC300	SC300	SC300	SC300						

Inserts & Collars Sold Separately

Examples:

If you need a Female JIC Swivel Fitting for a 08-SCW Hose (1/2" Convoluted), place an order for (1) 08-08 FJX-S and (1) 08-SC300.

If you need a Male Pipe Fitting for a 12-RCTW Hose, place an order for (1) 12-12 MP-S and (1) 12-RC300.

By Style

Size	ST300	SC300	PC300	SBF300	SIL 300	RC300
	For use with STW/STB	For use with SCW/SCB, SCWV/SCBV, CWV/CBV, NCW/NCB, NCWV/NCBV	For use with PCW/PCB, PCWV/PCBV	For use with SBFW/SBFB	For use with SBP/SWPV	For use with RCTW/RCTB
1/4"	04-ST300	04-SC300	04-PC300	—	04-SIL300	—
3/8"	06-ST300	06-SC300	06-PC300	06-SBF300	06-SIL300	—
1/2"	08-ST300	08-SC300	08-PC300	08-SBF300	08-SIL300	08-RC300
3/4"	12-ST300	12-SC300	12-PC300	12-SBF300	12-SIL300	12-RC300
1"	16-ST300	16-SC300	16-PC300	16-SBF300	16-SIL300	16-RC300
1-1/4"	20Z-ST300	20-SC300	20-PC300	—	—	20-RC300
1-1/2"	—	24-SC300	24-PC300	24-SBF300	24-SIL300	24-RC300
2"	—	32-SC300	32-PC300	—	32-SIL300	32-RC300
3"	—	48-SC300	48-PC300	—	—	48-RC300
4"	—	64-SC300	64-PC300	—	—	64-RC300

Note: Also available in carbon steel.

Adapters For JIC to NPT

True Bore Smoothbore Adapters

PARKER PAGE JIC (SAE) to NPT Adapters are designed to be used with any PARKER PAGE Field Attachable Fittings that have Female JIC (SAE) 37° swivels. PARKER PAGE adapters allow an effortless connection between Industrial smoothbore PTFE Hose assemblies with Female JIC (SAE) 37° swivels connecting to Pipe Threads (NPT). These adapters can simplify the most difficult assembly routing

problems by eliminating the need to rotate the hose assembly in order to make a threaded connection. By simply loosening the swivel ends and extracting the old assembly, a replacement assembly with swivel ends can be installed in minutes. PARKER PAGE Adapters are available in most common industrial configurations in 316 Stainless Steel, Carbon Steel and Brass.

Features

- For NPT to JIC
- Easy connection

Options

- Application specific designs available

FTX Male Pipe Adapter, 37° Flare/NPTF

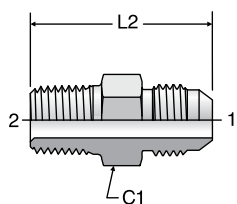

Part Number	Original "PAGE" No.	End Size 1		End Size 2	Hex C1		L2		Standard Dynamic Pressure (x 1,000 psi)		
		inch	mm		inch	mm	inch	mm	-s	-ss	-b
#	#										
Hose Fitting	Hose Fitting	inch	mm	NPTF	inch	mm	inch	mm	-s	-ss	-b
4-4 FTX	2404-04-04-*	1/4	6	1/4-18	3/4	19	1.39	35	6.0	6.0	3.3
6 FTX	2404-06-04-*	3/8	10	1/4-18	5/8	16	1.43	37	6.0	6.0	3.3
6-6 FTX	2404-06-06-*	3/8	10	3/8-18	3/4	19	1.44	37	6.0	6.0	3.3
8 FTX	2404-08-06-*	1/2	13	3/8-18	13/16	21	1.53	39	6.0	6.0	3.3
8-8 FTX	2404-08-08-*	1/2	13	1/2-14	7/8	22	1.78	45	6.0	6.0	3.3
10 FTX	2404-10-08-*	5/8	16	1/2-14	15/16	24	1.89	48	5.0	5.0	3.3
12 FTX	2404-12-12-*	3/4	19	3/4-14	1-1/8	29	2.06	52	5.0	5.0	2.6
16 FTX	2404-16-16-*	1	25	1-11 1/2	1-3/8	35	2.30	58	4.5	4.5	2.0
20FTX	2404-20-20-*	1-1/4	32	1-1/4-11 1/2	1-11/16	43	2.45	62	3.0	3.0	1.6

Construction: Replace * with -s (carbon steel), -ss (stainless steel) or -b (brass).

Adapters

GTX Female Pipe Adapter, 37° Flare/NPTF

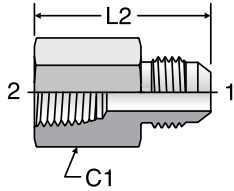

Part Number	Original "PAGE" No.	End Size 1		End Size 2		Hex C1		L2		Standard Dynamic Pressure (x 1,000 psi)		
		inch	mm	NPTF	inch	mm	inch	mm	-s	-ss	-b	
#	#											
Hose Fitting	Hose Fitting	inch	mm	NPTF	inch	mm	inch	mm	-s	-ss	-b	
4 GTX	2405-04-02-*	1/4	6	1/8-27	9/16	14	1.19	30	6.0	6.0	3.3	
4-4 GTX	2405-04-04-*	1/4	6	1/4-18	3/4	19	1.39	35	6.0	6.0	3.3	
5-4 GTX	2405-05-04-*	5/16	8	1/4-18	3/4	19	1.39	35	6.0	6.0	3.3	
6 GTX	2405-06-04-*	3/8	10	1/4-18	3/4	19	1.41	36	6.0	6.0	3.3	
6-6 GTX	2405-06-06-*	3/8	10	3/8-18	7/8	22	1.46	37	6.0	6.0	3.3	
8 GTX	2405-08-06-*	1/2	13	3/8-18	7/8	22	1.56	40	6.0	6.0	3.3	
8-8 GTX	2405-08-08-*	1/2	13	1/2-14	1-1/8	29	1.79	45	5.0	5.0	3.3	
10 GTX	2405-10-08-*	5/8	16	1/2-14	1-1/8	29	1.89	48	5.0	5.0	3.3	
12 GTX	2405-12-12-*	3/4	19	3/4-14	1-3/8	35	2.06	52	4.0	4.0	2.6	
16 GTX	2405-16-16-*	1	25	1-11/12	1-5/8	41	2.35	60	3.0	3.0	2.0	

Construction: Replace * with -s (carbon steel), -ss (stainless steel) or -b (brass).

Adapters

CTX Male Elbow, 37° Flare/NPTF

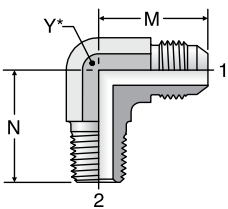

Part Number	Original "PAGE" No.	End Size 1		End Size 2		M		N		Y		Standard Dynamic Pressure (x 1,000 psi)		
		inch	mm	NPTF	inch	mm	inch	mm	inch	mm	-s	-ss	-b	
#	#													
Hose Fitting	Hose Fitting	inch	mm	NPTF	inch	mm	inch	mm	inch	mm	-s	-ss	-b	
4-4 CTX	2501-04-04-*	1/4	6	1/4-18	1.05	27	1.09	28	9/16	14	6.0	6.0	3.3	
6-6 CTX	2501-06-06-*	3/8	10	3/8-18	1.14	29	1.22	31	3/4	19	6.0	6.0	3.3	
8-8 CTX	2501-08-08-*	1/2	13	1/2-14	1.33	34	1.47	37	7/8	22	6.0	6.0	3.3	
12 CTX	2501-12-12-*	3/4	19	3/4-14	1.66	42	1.59	40	1-1/16	27	4.0	4.0	2.6	
16 CTX	2501-16-16-*	1	25	1-11/12	1.81	46	1.97	50	1-5/16	33	3.0	3.0	2.0	

Construction: Replace * with -s (carbon steel), -ss (stainless steel) or -b (brass).

PAGE INDUSTRIAL HOSE & FITTINGS



Nominal Hose



S30/S30B - Industrial .030" wall PTFE Hose, Stainless Steel Braid



Features

- High temperature hose
- Excellent chemical compatibility
- Resists moisture
- Low friction minimizes pressure drops and deposits

Compliances

- FDA 21 CFR 177.1550 (Natural tube)

Applications/Markets



- Food & Beverage
- Pharmaceutical
- Fluid handling
- Chemical transfer
- Cosmetics
- Paint

Part Number		Nominal I.D.		Maximum O.D.		Maximum Working Pressure 72°F/ 23°C		Minimum Bend Radius		Vac. Rating Hg./72°F	Weight		Permanent Fitting Series	Field Attachable Series
#	#	⊙		⊙		↗		↘		U	lbs	kg		
Natural	Conductive	inch	mm	inch	mm	psi	bar	inch	mm	inch	lbs./ft.	kg./mtr.		
03-S30	03-S30B	1/8	3	.250	6	3,000	207	1-1/2	38	28	.05	.08	91	NA
04-S30	04-S30B	3/16	5	.305	8	3,000	207	2	51	28	.06	.09	91N	90
05-S30	05-S30B	1/4	6	.375	10	3,000	207	3	76	28	.11	.16	91N	90
06-S30	06-S30B	5/16	8	.430	11	2,500	172	4	102	28	.13	.20	91N	90
08-S30	08-S30B	13/32	10	.535	14	2,000	138	5	127	28	.15	.22	91N	90
10-S30	10-S30B	1/2	13	.636	16	1,750	121	6-1/2	165	28	.19	.28	91N	90
12-S30	12-S30B	5/8	16	.765	19	1,500	103	7-1/2	191	12	.24	.36	91N	90
16-S30	16-S30B	7/8	22	1.030	26	1,000	69	9	229	14	.31	.47	91N	90

Construction

Tube: S30 - Natural FDA Compliant PTFE
 S30B - Black Static-Dissipative PTFE
 Reinforcement: 304 Stainless Steel braid

Operating Parameters

Temperature Range:
 -100°F to +450°F (-73°C to +232°C)
 Min. Burst Pressure is 4x Max. Working Pressure at 72°F (23°C)
 All ratings based on 72°F/23°C
 Change in length at working pressure is +2% to -4%

Fittings

91N/91 Series – page 47
 90 Series – page 60

Notes

See page 6 for part numbering system

All dimensions nominal - Working pressures and vacuum ratings may vary depending upon end connections and process and temperature parameters.

S40/S40B - Industrial .040 wall Heavy Wall PTFE Hose, Stainless Steel Braid



Features

- 33% more PTFE
- High temperature hose
- Excellent chemical compatibility
- Improved bend radius
- Decreased gas permeation
- Low friction minimizes pressure drops and deposits

Compliances

- FDA 21 CFR 177.1550 (Natural tube)

Applications/Markets



- Food & Beverage
- Pharmaceutical
- Fluid handling
- Chemical transfer
- Cosmetics
- Paint

Part Number		Nominal I.D.		Maximum O.D.		Maximum Working Pressure 72°F/ 23°C		Minimum Bend Radius		Vac. Rating Hg./72°F	Weight		Permanent Fitting Series	Field Attachable Series
#	#													
Natural	Conductive	inch	mm	inch	mm	psi	bar	inch	mm	inch	lbs./ft.	kg./mtr.		
03-S40	03-S40B	1/8	3	.250	6	3,000	207	1-1/2	38	28	.05	.08	91	NA
04-S40	04-S40B	3/16	5	.320	8	3,000	207	2	51	28	.08	.13	91N	90
05-S40	05-S40B	1/4	6	.375	10	3,000	207	3	76	28	.11	.16	91N	90
06-S40	06-S40B	5/16	8	.435	11	2,500	172	4	102	28	.12	.18	91N	90
08-S40	08-S40B	13/32	10	.565	14	2,000	138	5	127	28	.16	.23	91N	90
10-S40	10-S40B	1/2	13	.656	17	1,750	121	6-1/2	165	28	.17	.25	91N	90
12-S40	12-S40B	5/8	16	.780	20	1,500	103	7-1/2	191	12	.19	.28	91N	90
16-S40	16-S40B	7/8	22	1.05	27	1,000	69	9	229	14	.49	.73	91N	90

Construction

Tube: S40 - Natural FDA Compliant PTFE
S40B - Black Static-Dissipative PTFE

Reinforcement: 304 Stainless Steel braid

Operating Parameters

Temperature Range:

-100°F to +450°F (-73°C to +232°C)

Min. Burst Pressure is 4x Max. Working Pressure at 72°F (23°C)

All ratings based on 72°F/23°C

Change in length at working pressure is +2% to -4%

Fittings

91N/91 Series - page 47

90 Series - page 60

Notes

See page 6 for part numbering system

All dimensions nominal - Working pressures and vacuum ratings may vary depending upon end connections and process and temperature parameters.



944B – 4,000-4,500 PSI W.P. High Temp Hose

PTFE Hose, Double Stainless Steel Braid



Features

- High temperature hydraulic hose
- Excellent chemical compatibility
- Resists moisture
- Low friction minimizes pressure drops and deposits

Applications/Markets



- General hydraulics
- Chemical transfer
- Compressed air/gases

Specialty

Part Number	Nominal I.D.		Maximum O.D.		Maximum Working Pressure 72°F/ 23°C		Minimum Bend Radius		Vac. Rating Hg./72°F	Weight	
	inch	mm	inch	mm	psi	MPa	inch	mm		lbs./ft.	kg./mtr.
#											
944B-4	15/64	6	.39	10	4,500	31.0	1.50	38	28	.11	.16
944B-6	5/16	8	.49	12	4,500	31.0	2.50	64	28	.17	.24
944B-8	7/16	11	.62	16	4,500	31.0	2.88	73	28	.25	.35
944B-10	1/2	13	.73	19	4,000	27.6	3.25	83	28	.31	.45
944B-12	5/8	16	.99	25	4,000	27.6	4.00	102	28	.74	1.05
944B-16	29/32	23	1.25	32	4,000	27.6	5.00	127	28	1.09	1.55

Construction

Tube: Black static-dissipative PTFE
Reinforcement: 304 Stainless Steel braid

Fittings

94 Series – page 59

Operating Parameters

Temperature Range:

-65°F to +400°F (-54°C to +204°C)

Change in length at working pressure is +2% to -2%

Min. Burst Pressure is 3x Max. Working Pressure at 72°F (23°C)

All ratings based on 72°F/23°C

Notes

Factory-made assemblies only

Not suggested for steam-cold water cycling applications

Reduce pressure to 3,000 psi (20.7MPa) for pressure impulse applications

All dimensions nominal - Working pressures and vacuum ratings may vary depending upon end connections and process and temperature parameters.

955B – 5,500 PSI W.P. High Temp Hose

PTFE Hose, Multiple Stainless Steel Braids



Features

- High temperature hydraulic hose
- Excellent chemical compatibility
- Resists moisture
- Low friction minimizes pressure drops and deposits

Applications/Markets



- General hydraulics
- Chemical transfer
- Compressed air/gases

Part Number	Nominal I.D.		Maximum O.D.		Maximum Working Pressure 72°F/ 23°C		Minimum Bend Radius		Vac. Rating Hg./72°F	Weight	
	inch	mm	inch	mm	psi	MPa	inch	mm	inch	lbs./ft.	kg./mtr.
#											
955B-4	15/64	6	.50	13	5,500	37.9	3.00	76	28	.23	.34
955B-6	5/16	8	.62	16	5,500	37.9	5.00	127	28	.24	.35
955B-8	7/16	11	.75	19	5,500	37.9	5.75	146	28	.46	.68
955B-10	1/2	13	.91	23	5,500	37.9	6.50	165	28	.91	1.34
955B-12	5/8	16	1.08	27	5,500	37.9	7.75	197	28	.92	1.36
955B-16	29/32	23	1.36	34	5,500	37.9	9.63	245	28	1.20	1.77

Construction

Tube: Black static-dissipative PTFE

Reinforcement: Multiple high density braids of 304 Stainless Steel

Operating Parameters

Temperature Range:

-65°F to +400°F (-54°C to +204°C)

Change in length at working pressure is +2% to -2%

Min. Burst Pressure is 16,000 psi at 73°F (23°C)

All ratings based on 72°F/23°C

Fittings

95 Series – page 59

Notes

Factory-made assemblies only

Not suggested for steam-cold water cycling applications

Reduce operating pressure to 4000 PSI (27.6 MPa) for impulse service applications

All dimensions nominal - Working pressures and vacuum ratings may vary depending upon end connections and process and temperature parameters.



Industrial Fittings

For S30, S40, 944B and 955B Hose

90, 91N/91, 94 and 95 Series - Crimp and Field Attachable Fittings

Works on the following hose types:

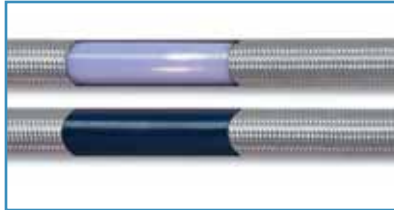

S30 & S40
uses 90 or 91N/91 Series



944B uses 94 &
955B uses 95 Series

Where applicable, “B” indicates Brass and “C” indicates Carbon Steel and “S” indicates Stainless Steel. For detailed ordering information, contact Customer Service.

Features

- Field attachable fittings allow users to work on-site
- Field attachable fittings required no expensive equipment

Options

- Stainless or Carbon Steel

Hose Fitting Insertion Values

Hose Dash Size	91N	92	93N
-2			
-3	7/16	9/16	
-4	1/2		
-5	9/16		
-6	5/8		7/16
-8	11/16		7/16
-10	11/16		3/4
-12	3/4		7/8
-16	15/16		15/16
-20	1		1
-24			1-1/8
-32			1-3/8

90, 91N/91, 94 & 95 Series Fitting Nomenclature

Example: 10391N-8-6





This example describes a permanent crimp 1/2" Male SAE JIC 37° with a 3/8" I.D. hose size. This fitting is constructed of steel since the designated material is blank.

- 10391N-8-6 – **Fitting Type** (1 = Permanent/Crimp)
- 10391N-8-6 – **End Configuration Code** (Male SAE JIC 37)
- 10391N-8-6 – **Fitting Series** (Series 91N)
- 10391N-8-6 – **End Size** (1/2")
- 10391N-8-6 – **Hose I.D.** (3/8")

Parker Fitting Material Selection

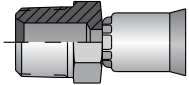
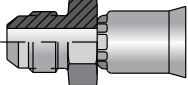
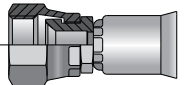
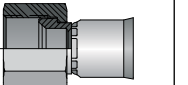
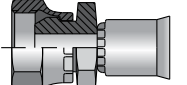
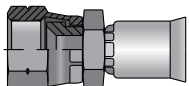
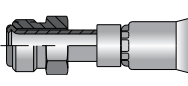
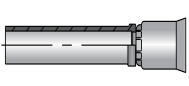
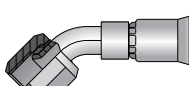
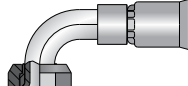
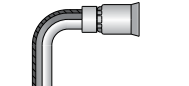
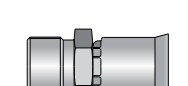
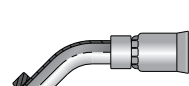
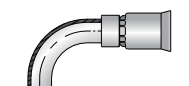
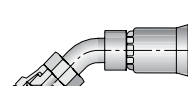
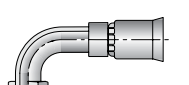
- Blank = Steel (unless otherwise noted)
- B = All Brass
- C = Stainless Steel
- S = All Carbon Steel – Used only with PTFE Fittings

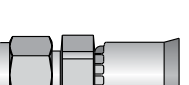
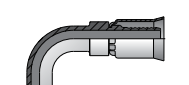
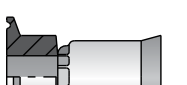
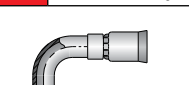
91N/91 Series Visual Index

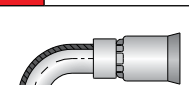
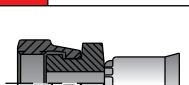
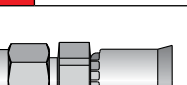
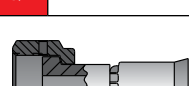
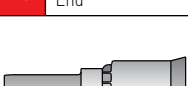
91N/91 Series PERMANENT	101 Male Taper Pipe Rigid  pg. 48	103 Male JIC 37°  pg. 48	106 JIC 37° Female Swivel  pg. 49	106 RD JIC 37° Female Swivel w/o Nip. Hex  pg. 49	107 Female Pipe Swivel  pg. 50
	108 Female SAE 45° Swivel  pg. 50	128 Male Inverted Swivel Straight  pg. 50	134 Straight Tube  pg. 51	137 Female JIC 37° Swivel 45° Elbow  pg. 51	139 Female JIC 37° Swivel 90° Elbow  pg. 52
	141 Female JIC 37° Swivel 90° Elb Long  pg. 52	161 Compression Air Brake  pg. 53	167 SAE Male Inverted 45° Elbow  pg. 53	169 SAE Male Inverted 90° Elbow  pg. 54	177 SAE 45° Swivel 45° Elbow  pg. 54
	179 Female SAE 45° Swivel 90° Elbow  pg. 54	192 BSP Female Swivel  pg. 58	1AL A-Lok® Compression  pg. 55	1B2 BSP Female Swivel 90° Elbow, Ballnose  pg. 58	1FN Sanitary Flange  pg. 55
	1J1 Female Seal-Lok™ 90° Elbow Long  pg. 56	1J7 Female Seal-Lok™ 45° Elbow  pg. 56	1J9 Female Seal-Lok™ 90° Elbow  pg. 57	1JC Female Seal-Lok™ Swive lStraight Short  pg. 57	1P6 CPI® Compression w/nut and ferrule  pg. 55
	1Q1 Female Ultra Seal  pg. 57	1TU Universal Tube Stub End  pg. 58			

91N/91
Fittings

10191N Male Taper Pipe Rigid

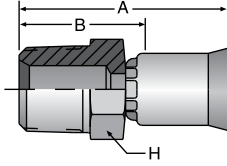

Part Number	Thread Size	Hose Size	A		Cutoff Allow. B		H Hex
			inch	mm	inch	mm	inch
#							
10191N-2-4	1/8-27	-4	1.27	32	3/4	19	7/16
10191N-4-4	1/4-18	-4	1.50	38	15/16	24	9/16
10191N-4-5	1/4-18	-5	1.55	39	15/16	24	9/16
10191N-4-6	1/4-18	-6	1.60	41	15/16	24	9/16
10191N-6-6	3/8-18	-6	1.65	58	1	25	11/16
10191N-6-8	3/8-18	-8	1.71	43	1	25	11/16
10191N-8-8	1/2-14	-8	1.94	49	1-1/4	32	7/8
10191N-8-10	1/2-14	-10	1.96	50	1-1/4	32	7/8
10191N-8-12	1/2-14	-12	2.42	61	1-1/4	32	1
10191N-12-12	3/4-14	-12	2.19	56	1-3/8	35	1-1/8
10191N-16-16	1-11-1/2	-16	2.46	62	1-1/2	38	1-3/8
10191-20-20	1-1/4-11-1/2	-20	3.05	77	2-1/16	52	1-3/4

Construction: Brass nipple, steel shell.

Add "B" for Brass nipple and shell.

Add "C" for Stainless Steel.

10391N Male (JIC) 37°

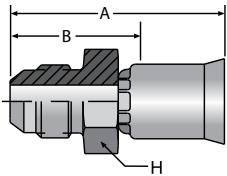

Part Number	Thread Size	Hose Size	A		Cutoff Allow. B		H Hex
			inch	mm	inch	mm	inch
#							
10391N-4-4	7/16-20	-4	1.37	35	13/16	21	1/2
10391N-5-5	1/2-20	-5	1.48	38	7/8	22	9/16
10391N-6-6	9/16-18	-6	1.64	42	1	25	11/16
10391N-8-8	3/4-16	-8	1.79	35	1-1/8	29	7/8
10391N-8-6	3/4-16	-6	1.73	44	1-1/16	27	7/8
10391N-10-10	7/8-14	-10	2.07	53	1-3/8	35	1
10391N-12-12	1-1/16-12	-12	2.10	53	1-5/16	33	1-1/8
10391N-16-16	1-5/16-12	-16	2.43	62	1-1/2	38	1-3/8

Construction: Brass nipple, steel shell.

Add "B" for Brass nipple and shell.

Add "C" for Stainless Steel.

10691N SAE (JIC) 37° Swivel

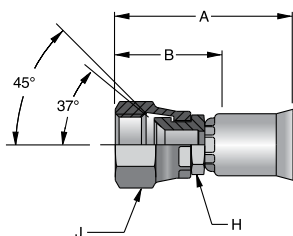

Part Number	Thread Size	Hose Size	A		Cutoff Allow. B		H Hex	J Hex
			inch	mm	inch	mm	inch	inch
#								
10691N-4-4	7/16-20	-4	1.43	36	7/8	22	3/8	9/16
10691N-5-5	1/2-20	-5	1.56	40	15/16	24	7/16	5/8
10691N-6-6	9/16-18	-6	1.63	41	1	25	1/2	11/16
10691N-6-8	9/16-18	-8	1.69	43	1	25	9/16	11/16
10691N-8-8	3/4-16	-8	1.89	48	1-3/16	30	11/16	7/8
10691N-8-10	3/4-16	-10	1.86	58	1-1/8	29	3/4	7/8
10691N-10-10	7/8-14	-10	2.03	52	1-5/16	33	13/16	1
10691N-12-12	1-1/16-12	-12	2.12	54	1-5/16	33	1	1-1/4
10691N-16-16	1-5/16-12	-16	2.45	62	1-9/16	40	1-1/4	1-1/2
10691-20-20	1-5/8-12	-20	2.98	76	1-13/16	46	1-11/16	2

Construction: Brass nipple, steel nut and shell.

Add "B" for Brass nipple, nut and shell.

Add S for Steel nipple, nut and shell.

Add "C" for Stainless Steel.

NOTE: Sizes -4, -5, -8 and -10 incorporate a dual seat.

10691NRD SAE (JIC) 37° Swivel

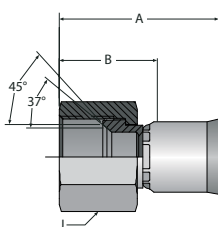

Part Number	Thread Size	Hose Size	A		Cutoff Allow. B		H Hex
			inch	mm	inch	mm	inch
#							
10691N-4-4-RD	7/16-20	-4	1.34	34	13/16	21	9/16
10691N-5-5-RD	1/2-20	-5	1.51	38	7/8	22	5/8
10691N-6-6-RD	9/16-18	-6	1.60	41	15/16	24	11/16
10691N-8-8-RD	3/4-16	-8	1.79	45	1-1/16	27	7/8
10691N-10-10-RD	7/8-14	-10	1.91	49	1-3/16	30	1
10691N-12-12-RD	1-1/16-12	-12	2.09	58	1-5/16	33	1-1/4
10691N-16-16-RD	1-5/16-12	-16	2.27	58	1-5/16	33	1-1/2

Construction: Brass nipple, steel nut and shell.

Add "B" for Brass nipple, nut and shell.

Add "C" for Stainless Steel.

NOTE: Sizes -4, -5, -8 and -10 incorporate a dual seat.

10791N Female Pipe Swivel

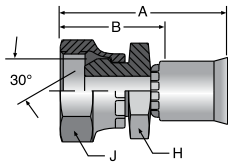

Part Number	Thread Size	Hose Size	A		Cutoff Allow. B		H Hex	J Hex
			inch	mm	inch	mm	inch	inch
#								
10791N-4-4	1/4-18	-4	1.50	38	15/16	24	9/16	11/16
10791N-6-6	3/8-18	-6	1.67	42	1	25	5/8	7/8
10791N-8-8	1/2-14	-8	1.83	46	1-1/8	29	3/4	1
10791N-10-10	3/4-14	-12	2.09	53	1-5/16	33	1	1-1/4
10791N-12-12	1-1/11-1/2	-12	2.26	57	1-5/16	33	1-3/16	1-3/8

Construction: Brass nipple, steel nut and shell.

Add "B" for Brass nipple, nut and shell.

Add "C" for Stainless Steel.

10891N SAE 45° Swivel

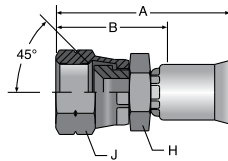

Part Number	Thread Size	Hose Size	A		Cutoff Allow. B		H Hex	J Hex
			inch	mm	inch	mm	inch	inch
#								
10891N-6-6	5/8-18	-6	1.69	43	1-1/16	27	5/8	3/4
10891N-12-12	1-1/16-14	-12	2.12	54	1-5/16	33	1	1-1/4

Construction: Brass nipple, steel nut and shell.

Add S for Steel nipple, nut and shell.

Add "C" for Stainless Steel.

12891N Male Inverted Swivel–Straight

91N/91
Fittings

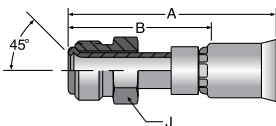

Part Number	Thread Size	Hose Size	A		Cutoff Allow. B		J Hex
			inch	mm	inch	mm	inch
#							
12891N-4-4	7/16-24	-4	2.09	53	1-1/2	38	7/16
12891N-5-5	1/2-20	-5	2.15	55	1-9/16	40	1/2
12891N-5-6	1/2-20	-6	2.23	57	1-9/16	40	1/2
12891N-6-6	5/8-18	-6	2.23	57	1-9/16	40	5/8
12891N-8-8	3/4-18	-8	2.31	59	1-5/8	41	3/4
12891N-10-10	7/8-18	-10	2.43	58	1-3/4	44	7/8
12891N-12-12	1-1/16-16	-12	2.50	64	1-11/16	43	1-1/16

Construction: Steel nipple, tube, nut and shell.

Add "C" for Stainless Steel.

13491N Straight Tube

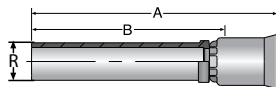

Part Number	Hose Size	Diameter R	A		Cutoff Allow. B	
			inch	mm	inch	mm
#						
13491N-8-8	-8	1/2	2.80	71	2-1/8	54
13491N-8-10	-10	1/2	2.81	71	2-1/8	54
13491N-10-10	-10	5/8	2.96	75	2-1/4	58
13491N-12-12	-12	3/4	3.37	86	2-9/16	65

Construction: Brass nipple, steel shell.

Add "B" for Brass nipple and shell.

Add "C" for Stainless Steel.

NOTE: The 16T91N fitting includes 13491N with the 60HAB sleeve and 61HAB nut.

13791N JIC 37° Swivel 45° Elbow

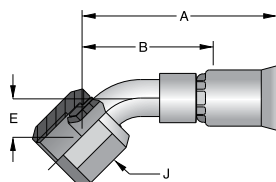

Part Number	Thread Size	Hose Size	A		Cutoff Allow. B		E		J Hex
			inch	mm	inch	mm	inch	mm	inch
#									
13791N-4-4	7/16-20	-4	1.74	44	1-3/16	30	0.33	8	9/16
13791N-5-5	1/2-20	-5	1.87	47	1-1/4	32	0.36	9	5/8
13791N-6-6	9/16-18	-6	1.94	49	1-5/16	33	0.43	11	11/16
13791N-8-8	3/4-16	-8	2.28	58	1-9/16	37	0.55	14	7/8
13791N-10-10	7/8-14	-10	2.42	61	1-11/16	43	0.64	43	1
13791N-12-12	1-1/16-12	-12	2.83	58	2-1/16	52	0.78	20	1-1/4
13791N-16-16	1-5/16-12	-16	3.18	81	2-1/4	57	0.89	23	1-1/2
13791-20-20	1-5/8-12	-20	3.67	93	2-9/16	65	1.10	28	2

Construction: Steel tube, nipple, nut and shell.

Add "C" for Stainless Steel.

13991N JIC 37° Swivel 90° Elbow Short Drop

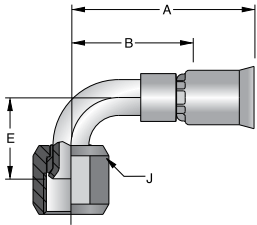

Part Number	Thread Size	Hose Size	A		Cutoff Allow. B		E		J Hex
			inch	mm	inch	mm	inch	mm	inch
#									
13991N-4-4	7/16-20	-4	1.62	41	1-1/16	37	0.68	17	9/16
13991N-5-5	1/2-20	-5	1.71	43	1-1/8	29	0.77	20	5/8
13991N-6-6	9/16-18	-6	1.91	49	1-1/4	32	0.91	23	11/16
13991N-8-8	3/4-16	-8	2.03	52	1-5/16	33	1.09	28	7/8
13991N-10-10	7/8-14	-10	2.27	58	1-9/16	37	1.23	43	1
13991N-12-12	1-1/16-12	-12	2.75	58	1-15/16	49	1.82	46	1-1/2
13991N-16-16	1-5/16-12	-16	3.15	80	2-3/16	56	2.14	52	1-1/2
13991-20-20	1-5/8-12	-20	3.53	90	2-7/16	62	1.18	30	2

Construction: Steel tube, nipple, nut and shell.

Add "C" for Stainless Steel.

14191N JIC 37° Swivel 90° Elbow Long Drop

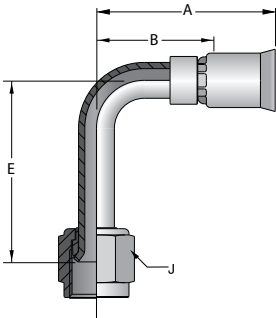

Part Number	Thread Size	Hose Size	A		Cutoff Allow. B		E		J Hex
			inch	mm	inch	mm	inch	mm	inch
#									
14191N-4-4	7/16-20	-4	1.66	42	1-1/8	29	1.80	46	9/16
14191N-5-5	1/2-20	-5	1.72	44	1-1/8	29	1.77	45	5/8
14191N-6-6	9/16-18	-6	1.93	49	1-5/16	33	2.13	54	11/16
14191N-8-8	3/4-16	-8	2.11	54	1-3/8	35	2.43	62	7/8
14191N-10-10	7/8-14	-10	2.34	59	1-5/8	41	2.57	65	1
14191N-12-12	1-1/16-12	-12	2.63	67	1-7/8	48	3.73	95	1-1/4
14191N-16-16	1-5/16-12	-16	3.15	80	2-3/16	56	4.33	110	1-1/2
14191-20-20	1-5/8-12	-20	4.00	102	2-15/16	75	5.28	134	2

Construction: Steel tube, nipple, nut and shell.

Add "C" for Stainless Steel.

16191N Compression Air Brake

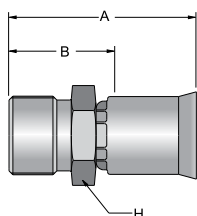

Part Number	Thread Size	Hose Size	A		Cutoff Allow. B		H Hex
			inch	mm	inch	mm	inch
#							
16191N-8-8	11/16-20	-8	1.61	41	15/16	24	3/4
16191N-8-10	11/16-20	-10	1.61	41	15/16	24	7/8
16191N-10-10	13/16-18	-10	1.82	46	1-1/8	29	15/16
16191N-12-12	1-18	-12	1.93	49	1-1/8	29	1-1/4

Construction: Brass nipple, steel shell.

Add "B" for Brass nipple and shell.

Add "C" for Stainless Steel.

16791N Male Inverted Swivel 45° Elbow

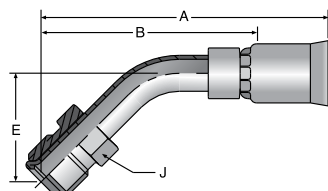

Part Number	Thread Size	Hose Size	A		Cutoff Allow. B		E		J Hex
			inch	mm	inch	mm	inch	mm	inch
#									
16791N-4-4	7/16-24	-4	2.05	52	1-1/2	38	0.63	16	7/16
16791N-5-5	1/2-20	-5	2.48	63	1-7/8	48	0.71	18	1/2
16791N-6-6	5/8-18	-6	2.60	66	1-15/16	49	0.96	24	5/8
16791N-8-8	3/4-18	-8	2.85	72	2-1/8	54	0.90	23	3/4
16791N-10-10	7/8-18	-10	3.30	84	2-5/8	67	1.02	43	7/8
16791N-12-12	1-1/16-16	-12	3.64	58	2-13/16	71	1.15	29	1-1/16

Construction: Steel tube, nipple, nut and shell.

Add "C" for Stainless Steel.

16991N Male Inverted Swivel 90° Elbow

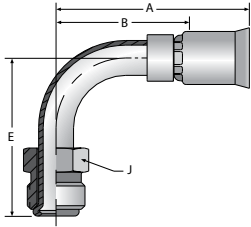

Part Number	Thread Size	Hose Size	A		Cutoff Allow. B		E		J Hex
			inch	mm	inch	mm	inch	mm	inch
#									
16991N-4-4	7/16-24	-4	1.72	44	1-3/16	30	1.19	30	7/16
16991N-5-5	1/2-20	-5	1.98	50	1-3/8	35	1.65	42	1/2
16991N-5-6	1/2-20	-6	2.03	52	1-7/16	37	1.65	42	1/2
16991N-6-6	5/8-18	-6	2.08	53	1-7/16	37	1.70	43	5/8
16991N-8-8	3/4-18	-8	2.18	55	1-1/2	38	1.87	43	3/4
16991N-10-10	7/8-18	-10	3.02	58	2-5/16	59	2.18	55	7/8
16991N-12-12	1-1/16-16	-12	3.36	85	2-9/16	64	2.51	64	1-1/16

Construction: Steel tube, nipple, nut and shell.
Add "C" for Stainless Steel.

17791N SAE 45° Swivel 45° Elbow

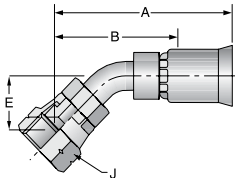

Part Number	Thread Size	Hose Size	A		Cutoff Allow. B		E		J Hex
			inch	mm	inch	mm	inch	mm	inch
#									
17791N-6-6	5/8-18	3/8	2.06	52	1-5/16	33	0.39	10	3/4
17791N-12-12	1-1/16-14	3/4	3.07	78	2-7/16	62	0.78	20	1-1/4

Construction: Steel tube, nipple, nut and shell.
Add "C" for Stainless Steel.

17991N SAE 45° Swivel 90° Elbow

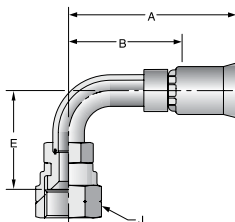

Part Number	Thread Size	Hose Size	A		Cutoff Allow. B		E		J Hex
			inch	mm	inch	mm	inch	mm	inch
#									
17991N-6-6	5/8-18	3/8	2.06	52	1-5/16	49	1.19	30	3/4
17991N-12-12	1-1/16-14	3/4	2.92	74	2-1/8	54	1.82	46	1-1/4

Construction: Steel tube, nipple, nut and shell.
Add "C" for Stainless Steel.

1AL91N A-LOK® Compression

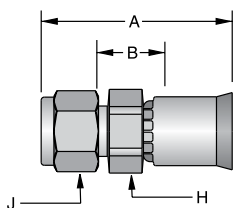

Part Number	Part Number	Hose Size	A		Cutoff Allow. B		H Hex	J Hex
#	#							
w/nut & ferrule	w/o nut & ferrules		inch	mm	inch	mm	inch	inch
1AL91N-4-4C	1AL91N-4-4NC	-4	1.30	33	7/16	11	1/2	9/16
1AL91N-4-5C	1AL91N-4-5NC	-5	1.35	34	7/16	11	1/2	9/16
1AL91N-6-6C	1AL91N-6-6NC	-6	1.53	39	1/2	13	5/8	11/16
1AL91N-8-8C	1AL91N-8-8NC	-8	1.61	41	7/16	11	13/16	7/8
1AL91N-12-12C	1AL91N-12-12NC	-12	1.86	47	1/2	13	1-1/8	1-1/8
1AL91N-16-16C	1AL91N-16-16NC	-16	2.11	58	7/16	11	1-3/8	1-1/2

Construction: Stainless steel nipple, nut, ferrules and shell.

Note: Nut part No. is **XNUX-316**;
Front ferrule part No. is **XFFX-316**;
Back ferrule part No. is **XBFX-316**.
X denotes dash size.

Nuts and Ferrules are Manufactured by the Instrumentation Products Division. Refer to Catalog 4230/4233 for Installation Instructions and Replacement Components.

1P691N CPI® Compression (With Nut and Ferrule)

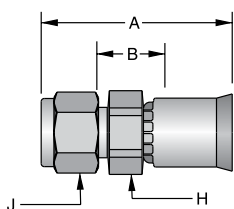

Part Number	Hose Size	A		Cutoff Allow. B		H Hex	J Hex
#							
w/nut & ferrules		inch	mm	inch	mm	inch	inch
1P691N-4-4C	-4	1.30	33	7/16	11	1/2	9/16
1P691N-6-6C	-6	1.53	39	1/2	13	5/8	11/16
1P691N-8-8C	-8	1.61	41	7/16	11	13/16	7/8

Construction: Stainless steel nipple and shell.

Note: Nut part No. is **XBZ-SS**;
Ferrule part No. is **XTZ-SS**;
X denotes dash size.

Nuts and Ferrules are Manufactured by the Instrumentation Products Division. Refer to Catalog 4230/4233 for Installation Instructions and Replacement Components.

1FN91N Sanitary Flange

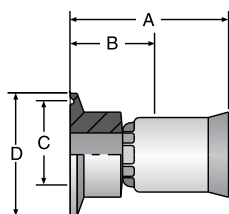

Part Number	Hose Size	A		Cutoff Allow. B		C		Flange Size D	
#									
		inch	mm	inch	mm	inch	mm	inch	mm
1FN91N-16-16C	-16	1.96	50	1-1/16	27	0.87	22	1.98	50

Construction: Stainless steel nipple and shell.

1J191N Female Seal-Lok™ Swivel 90° Elbow Long Drop

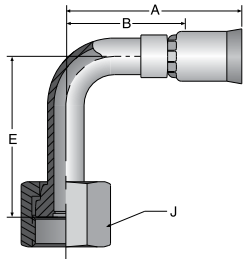

Part Number	Thread Size	Hose Size	A		Cutoff Allow. B		E		J Hex
			inch	mm	inch	mm	inch	mm	inch
#									
1J191N-4-4	9/16-18	-4	1.66	42	1-1/16	27	1.80	46	11/16
1J191N-4-5	9/16-18	-5	1.78	45	1-1/16	27	1.80	46	11/16
1J191N-6-5	11/16-16	-5	1.92	49	1-3/16	30	2.13	54	13/16
1J191N-6-6	11/16-16	-6	1.92	49	1-3/16	30	2.13	54	13/16
1J191N-8-6	13/16-16	-6	2.00	51	1-9/16	40	2.51	43	15/16
1J191N-8-8	13/16-16	-8	2.15	58	1-7/16	37	2.51	64	15/16
1J191N-10-10	1-14	-10	1.25	32	1-9/16	40	2.76	70	1-1/8
1J191N-12-12	1-3/16-12	-12	2.65	67	1-13/16	46	3.78	96	1-3/8
1J191N-16-16	1-7/16-12	-16	3.15	80	2-1/4	57	4.50	114	1-1/2

Construction: Steel tube, nipple, nut and shell.

Add "C" for Stainless Steel.

1J791N Female Seal-Lok™ Swivel 45° Elbow

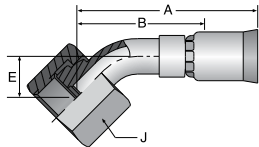

Part Number	Thread Size	Hose Size	A		Cutoff Allow. B		E		J Hex
			inch	mm	inch	mm	inch	mm	inch
#									
1J791N-4-4	9/16-18	-4	1.73	44	1-1/4	32	0.41	10	11/16
1J791N-4-6	9/16-18	-6	1.91	49	1-5/16	33	0.41	10	11/16
1J791N-6-6	11/16-16	-6	2.02	51	1-3/8	35	0.43	11	13/16
1J791N-8-8	13/16-16	-8	2.18	55	1-1/2	38	0.59	15	15/16
1J791N-8-10	13/16-16	-8	2.39	61	1-11/16	43	0.59	15	15/16
1J791N-10-10	1-14	-10	2.47	63	1-3/4	44	0.59	43	1-1/8
1J791N-12-12	1-3/16-12	-12	2.74	58	1-15/16	49	0.81	21	1-3/8
1J791N-16-16	1-7/16-12	-16	3.50	89	2-1/2	64	0.94	24	1-5/8

Construction: Steel tube, nipple, nut and shell.

Add "C" for Stainless Steel.

1J991N Female Seal-Lok™ Swivel 90° Elbow Short Drop

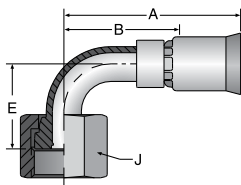

Part Number	Thread Size	Hose Size	A		Cutoff Allow. B		E		J Hex
			inch	mm	inch	mm	inch	mm	inch
#									
1J991N-4-4	9/16-18	-4	1.73	44	1-1/4	32	0.82	21	11/16
1J991N-6-6	11/16-16	-6	1.91	49	1-5/16	33	0.91	23	13/16
1J991N-8-8	13/16-16	-6	2.02	51	1-3/8	35	1.15	29	15/16
1J991N-10-10	1-14	-8	2.18	55	1-1/2	38	1.27	32	1-1/8
1J991N-12-12	1-3/16-12	-8	2.39	61	1-11/16	43	1.85	43	1-3/8
1J991N-16-16	1-7/16-12	-10	2.47	63	1-3/4	44	2.21	56	1-5/8

Construction: Steel tube, nipple, nut and shell.

Add "C" for Stainless Steel.

1JC91N Female Seal-Lok™ Swivel Straight

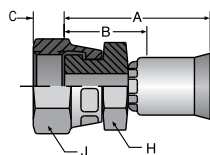

Part Number	Thread Size	Hose Size	A		Cutoff Allow. B		C		H Hex	J Hex
			inch	mm	inch	mm	inch	mm	inch	inch
#										
1JC91N-4-4	9/16-18	-4	1.46	37	5/8	16	.32	8	9/16	11/16
1JC91N-6-6	11/16-16	-6	1.62	41	11/16	17	.32	8	5/8	13/16
1JC91N-8-8	13/16-16	-8	1.93	49	13/16	21	.43	11	3/4	15/16
1JC91N-10-10	1-14	-10	2.05	52	7/8	22	.53	13	15/16	1-1/8
1JC91N-12-10	1-3/16-12	-10	2.05	52	1-1/4	32	.57	14	15/16	1-3/8
1JC91N-12-12	1-3/16-12	-12	2.05	58	1-1/4	32	.57	14	15/16	1-3/8
1JC91N-16-16	1-7/16-12	-16	2.56	65	1-1/16	27	.58	15	1-3/8	1-5/8
1JC91N-20-16	1-11/16-12	-16	2.30	58	1-3/8	35	.59	15	1-5/8	1-7/8
1JC91-20-20	1-11/16-12	-20	2.68	68	1-11/16	43	.59	15	1-11/16	1-7/8

Construction: Steel nipple, nut and shell.

Add "B" for Brass nipple, nut and shell.

Add "C" for Stainless Steel.

NOTE: When measuring overall length to the end of the nut, B+C dimensions must be used to calculate cut-off allowance. Stainless steel fittings must be assembled with Karrykrimp2, PHastkrimp, Superkrimp or Parkimp2. See CrimpSource for more information.

1Q191N Ultra Seal

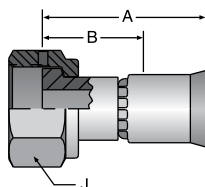

Part Number	Thread Size	Hose Size	A		Cutoff Allow. B		J Hex
			inch	mm	inch	mm	inch
#							
1Q191N-8-8C	7/8-20	-8	1.62	41	15/16	24	1

Construction: Stainless Steel.

1TU91N Universal Tube Stub

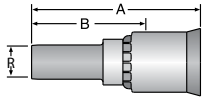

Part Number	Hose Size	Diameter R	A		Cutoff Allow. B	
			inch	mm	inch	mm
#						
1TU91-2-3C	-3	1/8	1.33	34	7/8	22
1TU91-3-3C	-3	3/16	1.33	34	7/8	22
1TU91N-4-4C	-4	1/4	1.63	41	1-1/16	27
1TU91N-4-5C	-5	1/4	1.70	43	1-1/16	27
1TU91N-6-6C	-6	3/8	1.81	46	1-3/16	30
1TU91N-8-8C	-8	1/2	2.72	58	1-7/16	37
1TU91N-8-10C	-10	1/2	2.14	54	1-7/16	37
1TU91N-10-10C	-10	5/8	2.14	54	1-7/16	37
1TU91N-12-12C	-12	3/4	2.24	57	1-7/16	37
1TU91N-16-16C	-16	1	2.73	69	1-3/4	44

Construction: Stainless Steel.

NOTE: Use with A-Lok & CPI nuts, sleeves and adapters. These components are manufactured by Parker's Instrumentation Connectors Division. Refer to catalogs 4230 & 4233 for additional information.

19291N Female BSP Swivel

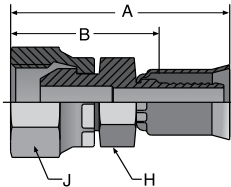

Part Number	Thread Size	Hose Size	A		Cutoff Allow. B		H Hex	J Hex
			inch	mm	inch	mm	inch	inch
#								
19291N-8-8	PF-1/2-14	-8	1.99	51	1-5/16	33	27	27
19291N-12-12	PF-3/4-14	-12	2.35	60	1-9/16	40	36	36

Construction: Steel nipple, nut and shell.

Add "B" for Brass nipple, nut and shell.

Add "C" for Stainless Steel.

1B291N Female BSP Swivel 90° Elbow

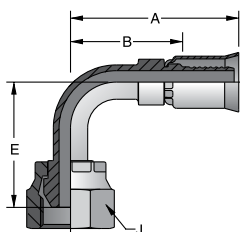

Part Number	Thread Size	Hose Size	A		Cutoff Allow. B		E		J Hex
			inch	mm	inch	mm	inch	mm	inch
#									
1B291N-8-8	PF-1/2-14	-8	2.04	52	1-3/8	35	1.57	40	27
1B291N-12-12	PF-3/4-14	-12	2.93	74	2-1/8	54	2.54	65	36

Construction: Steel nipple, nut and shell.

Add "C" for Stainless Steel.

94/95 Series Visual Index

94 Series

PERMANENT

106
SAE (JIC) 37° Female Swivel

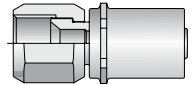

pg. 59

95 Series

PERMANENT

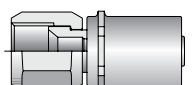

106
SAE (JIC) 37° Female Swivel

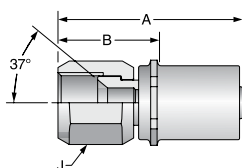

pg. 59

10694 SAE (JIC) 37° Female Swivel





Part Number	Thread Size	Hose Size	A		Cutoff Allow. B		J Hex
			inch	mm	inch	mm	inch
#							
10694-6-6	9/16-18	-6	1.76	45	15/16	24	11/16
10694-8-8	3/4-16	-8	2.09	53	1-3/16	30	7/8
10694-10-10	7/8-14	-10	2.30	58	1-5/16	33	1
10694-12-12	1-1/16-12	-12	2.45	62	1-5/16	33	1-1/4
10694-16-16	1-5/16-12	-16	2.72	69	1-7/16	37	1-1/2

Construction: Steel nipple, nut and shell.
Add "C" for Stainless Steel.

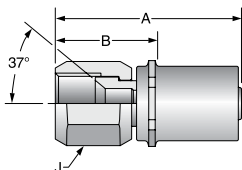
10695 SAE (JIC) 37° Female Swivel







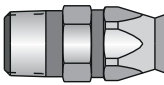

Part Number	Thread Size	Hose Size	A		Cutoff Allow. B		J Hex
			inch	mm	inch	mm	inch
#							
10695-4-4	7/16-20	-4	1.76	45	15/16	24	11/16
10695-6-6	9/16-18	-6	2.09	53	1-3/16	30	7/8
10695-8-8	3/4-16	-8	2.30	58	1-5/16	33	1
10695-12-12	1-1/16-12	-12	2.45	62	1-5/16	33	1-1/4
10695-16-16	1-5/16-12	-16	2.72	69	1-7/16	37	1-1/2

Construction: Steel nipple, nut and shell.
Add "C" for Stainless Steel.

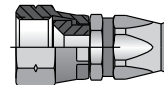
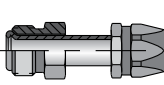
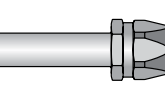
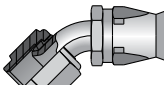
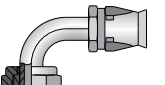
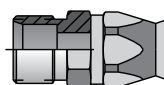
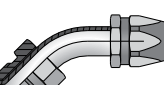
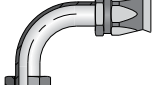
94/95 Fittings

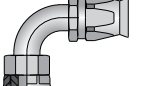
90 Series Visual Index

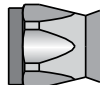
90 Series FIELD ATTACHABLE	201 Male Taper Pipe Rigid  pg. 60	206 SAE (JIC) 37° Swivel  pg. 61	208 SAE 45° Swivel  pg. 61	228 SAE Male Inverted Swivel Straight  pg. 61	234 Straight Tube  pg. 62
	237 JIC 37° Swivel 45° Elbow  pg. 62	239 JIC 37° Swivel 90° Elbow  pg. 62	261 SAE Compression Air Brake  pg. 63	267 SAE Male Inverted Swivel 45° Elbow  pg. 63	269 SAE Male Inverted Swivel 90° Elbow  pg. 63
	277 45° Swivel 45° Elbow  pg. 64	279 45° Swivel 90° Elbow  pg. 64			

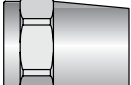
90 Series REPLACEMENT COMPONENTS	200 Replacement Socket  pg. 65	090 Replacement Ferrule  pg. 65	60HAB Compression Airbrake Sleeve  pg. 65	61HAB Compression Airbrake Nut  pg. 65

20190 Male Taper Pipe Rigid

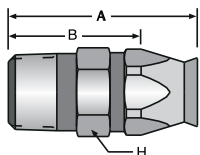

Part Number	Thread Size	Hose Size	A		Cutoff Allow. B		H Hex
			inch	mm	inch	mm	inch
#							
20190-2-4	1/8-27	-4	1.33	34	7/8	22	9/16
20190-4-4	1/4-18	-4	1.58	40	1-1/16	27	9/16
20190-4-5	1/4-18	-5	1.66	42	1-1/8	29	5/8
20190-4-6	1/4-18	-6	1.66	42	1-1/8	29	11/16
20190-6-6	3/8-18	-6	1.66	42	1-1/8	29	11/16
20190-6-8	3/8-18	-8	1.77	45	1-3/16	30	7/8
20190-8-8	1/2-14	-8	1.97	50	1-7/16	37	7/8
20190-8-10	1/2-14	-10	2.13	54	1-7/16	37	1
20190-12-12	3/4-14	-12	2.26	57	1-9/16	40	1-1/8
20190-12-16	3/4-14	-16	2.29	58	1-5/8	41	1-3/8
20190-16-16	1-11-1/2	-16	2.46	62	1-7/8	48	1-3/8
20190-20-20	1-1/4-11-1/2	-20	2.69	68	2-1/16	52	2

Construction: Brass nipple and ferrule, steel socket.

Add "C" for Stainless Steel.

20690 SAE (JIC) 37° Swivel

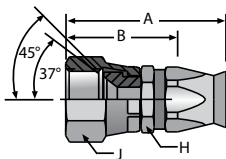

Part Number	Thread Size	Hose Size	A		Cutoff Allow. B		H Hex	J Hex
			inch	mm	inch	mm	inch	inch
#								
20690-4-4	7/16-20	-4	1.58	40	1-1/8	29	9/16	9/16
20690-5-5	1/2-20	-5	1.66	42	1-1/8	29	5/8	5/8
20690-6-6	9/16-18	-6	1.74	44	1-3/16	35	11/16	11/16
20690-8-6	3/4-16	-6	1.85	47	1-5/16	33	7/8	7/8
20690-8-8	3/4-16	-8	1.98	50	1-3/8	35	7/8	7/8
20690-8-10	3/4-16	-10	2.07	53	1-7/16	37	1	7/8
20690-10-10	7/8-14	-10	2.22	56	1-1/2	38	1	1
20690-12-12	1-1/16-12	-12	2.33	59	1-5/8	41	1-1/4	1-1/4
20690-16-16	1-5/16-12	-16	2.52	64	1-15/16	49	1-3/8	1-1/2
20690-20-20	1-5/8-12	-20	2.99	76	2-5/16	59	2	2

Construction: Brass nipple and ferrule, steel nut and socket.

Add "C" for Stainless Steel.

NOTE: Sizes -4, -5, -8 and -10 incorporate a dual seat.

20890 SAE 45° Swivel

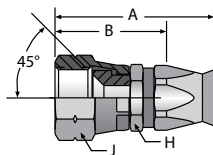

Part Number	Thread Size	Hose Size	A		Cutoff Allow. B		H Hex	J Hex
			inch	mm	inch	mm	inch	inch
#								
20890-6-6	5/8-18	-6	1.77	45	1-1/4	32	11/16	3/4
20890-12-12	1-1/16-14	-12	2.34	59	1-11/16	43	1-1/8	1-1/4

Construction: Brass nipple and ferrule, steel nut and socket.

Add "C" for Stainless Steel.

22890 SAE Male Inverted Swivel-Straight

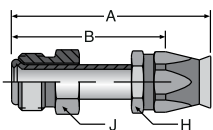

Part Number	Thread Size	Hose Size	A		Cutoff Allow. B		H Hex	J Hex
			inch	mm	inch	mm	inch	inch
#								
22890-4-4	7/16-24	-4	2.15	55	1-11/16	43	9/16	7/16
22890-5-5	1/2-20	-5	2.21	56	1-11/16	43	5/8	1/2
22890-5-6	1/2-20	-6	2.20	56	1-11/16	43	11/16	1/2
22890-6-6	5/8-18	-6	2.22	56	1-11/16	43	11/16	5/8
22890-8-8	3/4-18	-8	2.34	59	1-13/16	46	13/16	3/4
22890-10-10	7/8-18	-10	2.53	64	1-7/8	48	15/16	7/8
22890-12-12	1-1/16-16	-12	3.01	76	2-3/8	60	1-1/8	1-1/16

Construction: Brass ferrule, steel tube, nut and socket.

Add "C" for Stainless Steel.

23490 Straight Tube

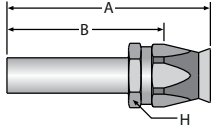

Part Number	Hose Size	Tube Size		A		Cutoff Allow. B		H Hex
		inch	mm	inch	mm	inch	mm	inch
#								
23490-8-8	-8	1/2	6	3.06	78	2-1/2	64	13/16
23490-8-10	-10	1/2	8	3.15	80	2-1/2	64	1
23490-10-8	-8	5/8	8	3.26	83	2-5/8	67	13/16
23490-10-10	-10	5/8	10	3.28	83	2-5/8	67	1
23490-12-12	-12	3/4	13	3.28	83	2-11/16	68	1-1/8

Construction: Brass nipple and ferrule, steel socket.

Add "C" for Stainless Steel.

NOTE: 26T90 fitting includes 23490 with the 60HAB sleeve and 61HAB nut.

23790 JIC 37° Swivel 45° Elbow

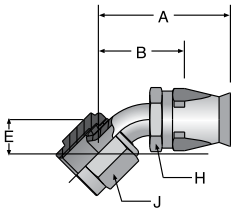

Part Number	Thread Size	Hose Size	A		Cutoff Allow. B		E		H Hex	J Hex
			inch	mm	inch	mm	inch	mm	inch	inch
#										
23790-4-4	7/16-20	-4	1.79	45	1-3/8	35	0.33	8	9/16	9/16
23790-5-5	1/2-20	-5	1.86	47	1-3/8	35	0.36	9	5/8	5/8
23790-6-6	9/16-18	-6	1.96	50	1-7/16	37	0.39	10	11/16	11/16
23790-8-6	3/4-16	-6	2.11	54	1-11/16	43	0.55	14	11/16	7/8
23790-8-8	3/4-16	-8	2.40	61	1-3/4	44	0.55	14	13/16	7/8
23790-10-10	7/8-14	-10	2.45	62	1-7/8	48	0.63	16	15/16	1
23790-12-12	1-1/16-12	-12	3.04	77	2-7/16	62	0.78	20	1-1/8	1-1/4
23790-16-16	1-5/16-12	-16	3.28	83	2-11/16	68	0.90	23	1-3/8	1-1/2
23790-20-20	1-5/8-12	-20	3.70	94	3-1/16	78	1.18	30	1-3/4	2

Construction: Brass ferrule, steel tube, nut and socket.

Add "C" for Stainless Steel.

23990 JIC 37° Swivel 90° Elbow Short Drop

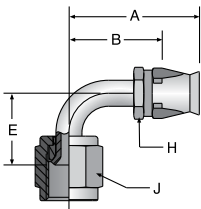

Part Number	Thread Size	Hose Size	A		Cutoff Allow. B		E		H Hex	J Hex
			inch	mm	inch	mm	inch	mm	inch	inch
#										
23990-4-4	7/16-20	-4	1.67	41	1-1/4	32	0.83	21	9/16	9/16
23990-5-5	1/2-20	-5	1.75	44	1-1/4	32	0.83	21	5/8	5/8
23990-6-6	9/16-18	-6	1.84	47	1-5/16	33	0.91	23	11/16	11/16
23990-8-6	3/4-16	-6	1.94	49	1-7/16	37	1.14	29	11/16	7/8
23990-8-8	3/4-16	-8	2.14	54	1-9/16	40	1.14	29	13/16	7/8
23990-10-10	7/8-14	-10	2.38	60	1-3/4	44	1.23	31	15/16	1
23990-12-12	1-1/16-12	-12	2.95	75	2-5/16	59	1.82	46	1-1/8	1-1/4
23990-16-16	1-5/16-12	-16	3.13	80	2-1/2	64	2.14	54	1-3/8	1-1/2
23990-20-20	1-5/8-12	-20	3.54	90	2-7/8	73	2.57	65	1-3/4	2

Construction: Brass ferrule, steel tube, nut and socket.

Add "C" for Stainless Steel.

26190 SAE Compression Air Brake

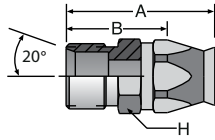

Part Number	Thread Size	Hose Size	A		Cutoff Allow. B		H Hex
			inch	mm	inch	mm	inch
#							
26190-8-8	11/16-20	-8	1.69	43	1-1/16	27	13/16
26190-8-10	11/16-20	-10	1.86	47	1-3/16	30	1
26190-10-10	13/16-18	-10	1.92	49	1-1/4	32	1
26190-12-10	1-18	-10	2.09	53	1-7/16	37	1
26190-12-12	1-18	-12	2.09	53	1-7/16	37	1-1/8

Construction: Brass nipple and ferrule, steel socket.

Add "B" for Brass nipple and socket.

Add "C" for Stainless Steel.

26790 SAE Male Inverted Swivel 45° Elbow

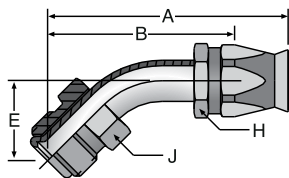

Part Number	Thread Size	Hose Size	A		Cutoff Allow. B		E		H Hex	J Hex
			inch	mm	inch	mm	inch	mm	inch	inch
#										
26790-4-4	7/16-24	-4	2.11	54	1-11/16	43	0.63	16	9/16	7/16
26790-5-5	1/2-20	-5	2.51	64	2	51	0.94	24	5/8	1/2
26790-5-6	1/2-20	-6	2.55	65	2-1/16	52	0.94	24	11/16	1/2
26790-6-6	5/8-18	-6	2.61	66	2-1/8	54	0.94	24	11/16	5/8
26790-8-8	3/4-18	-8	2.97	75	2-3/8	60	0.94	24	13/16	3/4
26790-8-10	3/4-18	-10	3.05	77	2-7/16	62	0.94	24	15/16	3/4
26790-10-10	7/8-18	-10	3.43	87	2-11/16	68	1.02	26	15/16	7/8
26790-12-12	1-1/16-16	-12	3.83	97	3-3/16	81	1.15	29	1-1/8	1-1/16

Construction: Brass ferrule, steel tube, nut and socket.

Add "C" for Stainless Steel.

26990 SAE Male Inverted Swivel 90° Elbow

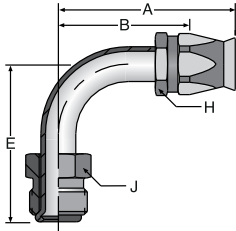

Part Number	Thread Size	Hose Size	A		Cutoff Allow. B		E		H Hex	J Hex
			inch	mm	inch	mm	inch	mm	inch	inch
#										
26990-4-4	7/16-24	-4	1.79	45	1-5/16	33	1.19	30	9/16	7/16
26990-5-5	1/2-20	-5	2.01	51	1-1/2	38	1.65	42	5/8	1/2
26990-5-6	1/2-20	-6	2.05	52	1-9/16	40	1.65	42	11/16	1/2
26990-6-6	5/8-18	-6	2.03	52	1-1/2	38	1.70	43	11/16	5/8
26990-8-8	3/4-18	-8	2.30	58	1-11/16	43	1.78	45	13/16	3/4
26990-8-10	3/4-18	-10	2.39	61	1-3/4	44	1.78	45	15/16	3/4
26990-10-10	7/8-18	-10	3.16	80	2-1/2	64	2.18	55	15/16	7/8
26990-12-12	1-1/16-16	-12	3.56	90	2-15/16	75	2.51	64	1-1/8	1-1/16

Construction: Brass ferrule, steel tube, nut and socket.

Add "C" for Stainless Steel.

27790 SAE 45° Swivel 45° Elbow

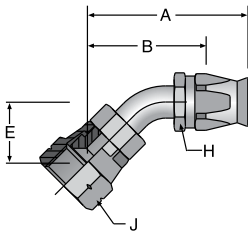

Part Number	Thread Size	Hose Size	A		Cutoff Allow. B		E		H Hex	J Hex
			inch	mm	inch	mm	inch	mm	inch	inch
#										
27790-6-6	5/8-18	-6	1.72	44	1-3/16	30	0.39	10	11/16	3/4
27790-12-12	1-1/16-14	-12	3.03	77	2-3/8	60	0.78	20	1-1/8	1-1/4

Construction: Brass ferrule, steel tube, nut and socket.

Add "C" for Stainless Steel.

27990 SAE 45° Swivel 90° Elbow

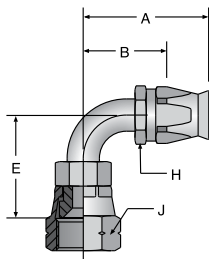

Part Number	Thread Size	Hose Size	A		Cutoff Allow. B		E		H Hex	J Hex
			inch	mm	inch	mm	inch	mm	inch	inch
#										
27990-4-4	7/16-20	-4	1.67	42	1-1/4	32	.68	17	9/16	9/16
27990-5-5	1/2-20	-5	1.75	44	1-1/4	32	.77	20	5/8	5/8
27990-6-6	5/8-18	-6	1.86	47	1-3/8	35	.85	22	11/16	3/4
27990-8-8	3/4-16	-8	2.09	53	1-1/2	38	1.09	28	13/16	7/8
27990-12-12	1-1/16-14	-12	2.95	75	2-5/16	39	1.82	46	1-1/8	1-1/4

Construction: Brass ferrule, steel tube, nut and socket.

Add "C" for Stainless Steel.

20090 Replacement Socket for Field Attachable Fittings

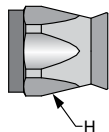

Part Number	H Hex
#	
	inch
20090-4	9/16
20090-5	5/8
20090-6	11/16
20090-8	7/8
20090-10	1
20090-12	1-1/8
20090-16	1-3/8
20090-20	1-3/4

Construction: Steel or Stainless Steel.
Add "C" for Stainless Steel.

60 HAB SAE Compression Airbrake Sleeve

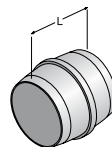

Part Number	Tube Size		L
	inch	mm	
#			
	inch	mm	inch
60HAB-4	1/4	6	.250
60HAB-6	3/8	10	.313
60HAB-8	1/2	13	.375
60HAB-10	5/8	16	.438
60HAB-12	3/4	19	.500

Construction: Brass.

NOTE: To be used with 13491N & 23490.

090 Replacement Ferrule for 90 Series Field Attachable Fittings

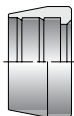

Part Number	Hose Size
#	
090-4B	-4
090-5B	-5
090-6B	-6
090-8B	-8
090-10B	-10
090-12B	-12
090-16B	-16
090-20B	-20

Construction: Brass.

Replace "B" with "C" for Stainless Steel.

61 HAB SAE Compression Airbrake Nut

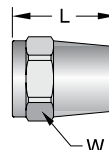

Part Number	Thread Size	Tube Size		L		W Hex
		inch	mm	inch	mm	
#						
		inch	mm	inch	mm	inch
61HAB-4	7/16-24	1/4	6	0.75	19	9/16
61HAB-6	7/32-24	3/8	10	1.13	29	5/8
61HAB-8	11/16-20	1/2	13	1.25	32	13/16
61HAB-10	13/16-18	5/8	16	1.38	35	15/16
61HAB-12	1-18	3/4	19	1.56	40	1-1/8

Construction: Brass.

NOTE: To be used with 13491N & 23490 Fittings.



Accessories For Fluoropolymer Hoses

Harsh environments sometimes require assemblies with silicone fire sleeves, fluoropolymer heat shrink, polyolefin shrinkable chafe guard, spring guards or interlocked casings to prolong the life of the hose. PARKER PAGE manufactures every hose style with these options available.

minimal compared to the savings you gain by keeping the hose operating longer in the field. Most of these product enhancements are available for hoses sized from 1/4" up to 4" and can be provided on almost any hose. In addition, several of the value added accessories may be purchased separately, allowing customers to value-up their existing hoses.

Maximizing hose performance by adding cost reducing accessories such as Armor Guard, to increase the abrasion resistance of the hose, or a Fire Sleeve, to maintain an outer hose temperature for operator handling, can add weeks, months, and in some cases, even years to hose life. Cost for hose enhancing accessories is

Features

- Extends hose life
- Maximizes performance
- Increased abrasion resistance
- Reduces downtime
- Cover promotes safe operator handling



SFS Series Silicone Fire Sleeve

Hose Number	Fire Sleeve Number
-03	SFS-08
-04	SFS-08
-05	SFS-08
-06	SFS-12
-08	SFS-12
-10	SFS-12
-12	SFS-16
-16	SFS-20
-16Z	SFS-20
-20Z	SFS-24



TESTED in accordance with:
UL-73, NFPA-250, ASTM-E84

OPERATING TEMPERATURES:

Continuous: -65°F to +500°F (-18°C to +260°C)

Intermittent: -65°F to +2000°F (-18°C to +1093°C)

PARKER PAGE Fire Sleeve has a coating of specially compounded silicone rubber bonded to a low density high bulk fiberglass sleeve. This unique combination offers a temporary barrier to flame penetration and provides long term mechanical and environmental protection. Applications include steel manufacturing plants, foundries, glass factories and welding/cutting shops.

SG Series Spring Guard

Dash Number	Part Number	Hose Number	Spring Guard Number
-04	SG-04	-12	SG-12
-05	SG-05	-16	SG-16
-06	SG-06	-16Z	SG-16Z
-08	SG-08	-20Z	SG-20Z
-10	SG-10	-	-



PARKER PAGE Spring Guard is available in hot dipped galvanized carbon steel. This method of protection is well suited for applications where hose assemblies are subjected to rough handling, abrasion and severe flexing. A stainless steel internal support spring is also available for vacuum applications.

B2 Polyolefin Heat Shrink

Hose Number	Polyolefin HS
-03	B2-08-XXX
-04	B2-08-XXX
-05	B2-08-XXX
-06	B2-12-XXX
-08	B2-12-XXX
-10	B2-12-XXX
-12	B2-16-XXX
-16	B2-24-XXX
-16Z	B2-24-XXX
-20Z	B2-24-XXX



PARKER PAGE offers a very flexible, flame retarded, radiation crosslinked Polyolefin heat shrink to aid in the identification of hoses through color coding and also, protect surfaces from dirt and grim. Meets functional requirements of AMS-DTL-23053/5, Class 1E2.

COLORS AVAILABLE

RED= Red		BLK= Black	
WHI=White		BLU=Blue	
YEL=Yellow		GRY=Gray	

Custom Printing Available Fluoropolymer Heat Shrink Available

Note: Replace XXX with 3 letter indicator for color. See color chart. IE: B2-08-BLU = 1/2" Blue

OPERATING TEMPERATURES: Continuous: -65°F to +275°F (-18°C to +135°C)

SAG Armor Guard

Non Standard Product
Please contact Customer Service for sizing, delivery and pricing. 817.624.1329 • 800.847.7280 • email: pagequote@parker.com





Braiding Characteristics

BRAID TYPE	CHARACTERISTICS	POOR	FAIR	GOOD	EXCELLENT
STAINLESS STEEL Temperature Rating on Hose -100°F to +500°F (-73°C to +260°C)	Tensile Strength				●
	Abrasion Resistance				●
	Chemical Resistance			●	
	Corrosion Resistance			●	
	High Temperature Capabilities				●
	Durability			●	
	Personal Handling Safety			●	
POLYPROPYLENE Temperature Rating on Hose 0°F to +212°F (-18°C to +100°C)	Tensile Strength		●		
	Abrasion Resistance			●	
	Chemical Resistance			●	
	Corrosion Resistance				●
	High Temperature Capabilities	●			
	Durability			●	
	Personal Handling Safety				●
Kynar® (PVDF) Temperature Rating on Hose -40°F to +280°F (-40°C to +138°C)	Tensile Strength			●	
	Abrasion Resistance			●	
	Chemical Resistance				●
	Corrosion Resistance				●
	High Temperature Capabilities			●	
	Durability			●	
	Personal Handling Safety				●
KEVLAR® Temperature Rating on Hose -100°F to +350°F (-73°C to +177°C)	Tensile Strength				●
	Abrasion Resistance			●	
	Chemical Resistance		●		
	Corrosion Resistance				●
	High Temperature Capabilities			●	
	Durability		●		
	Personal Handling Safety				●
NOMEX® Temperature Rating on Hose -100°F to +400°F (-73°C to +204°C)	Tensile Strength		●		
	Abrasion Resistance			●	
	Chemical Resistance			●	
	Corrosion Resistance				●
	High Temperature Capabilities				●
	Durability			●	
	Personal Handling Safety				●

Other brand materials available such as Polyester, Monel and Hastelloy. Consult Customer Service for minimum quantities and special quotes.

Measuring Hose Assembly Length



Male Pipe x Female JIC Assembly



Female JIC x Female JIC Assembly

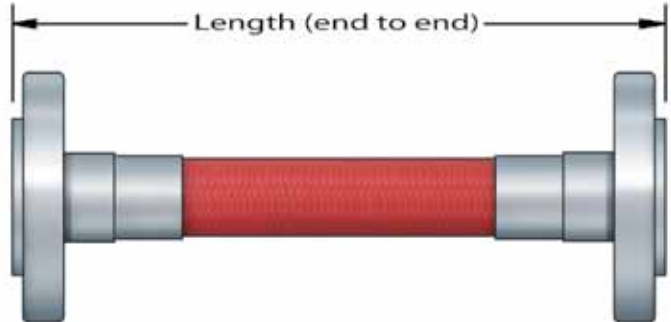

Flange x Flange assembly

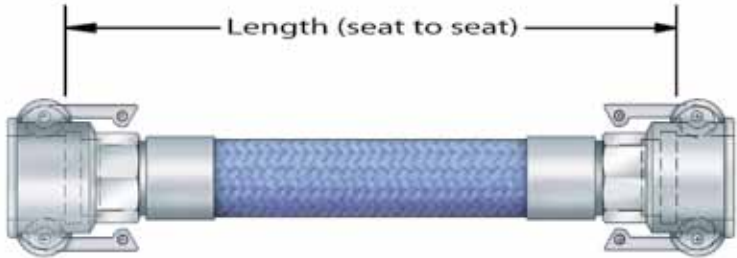

Cam & Groove x
Cam & Groove Assembly



Sanitary x Sanitary Assembly

Assembly Length Measurements For NAHAD Hose Assemblies

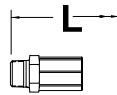

MALE PIPE

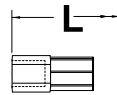

FEMALE PIPE

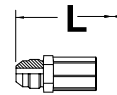

**MALE JIC
MALE SAE
MALE VACUSEAL
MALE CAM LOCK**

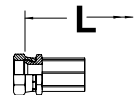

**FEMALE JIC SWIVEL
FEMALE SAE SWIVEL**

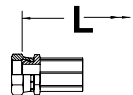

**FEMALE PIPE SWIVEL
FEMALE BSP SWIVEL**

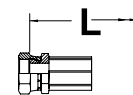

**FEMALE SEAL-LOK
ULTRA SEAL
FEMALE VACUSEAL
FEMALE BEVEL SEAT**



TUBE STUB

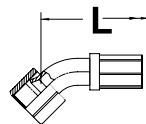

45° Elbow Fittings
EX. 45° JIC/SAE
45° SEAL-LOK
45° BSP SWIVEL

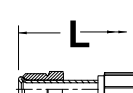

MALE INVERTED

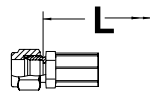

**ALOK
CPI**

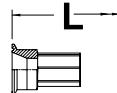

**SANITARY FLANGES
MALE BEVEL SEAT
FLANGE FITTINGS**

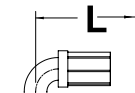

90° Elbow Fittings
EX. 90° JIC/SAE
90° SEAL-LOK
90° BSP SWIVEL

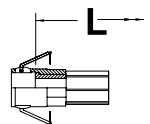

FEMALE CAM AND GROOVE

Assembly Length Measurements

For SAE Hose Assemblies (unless noted on drawing)

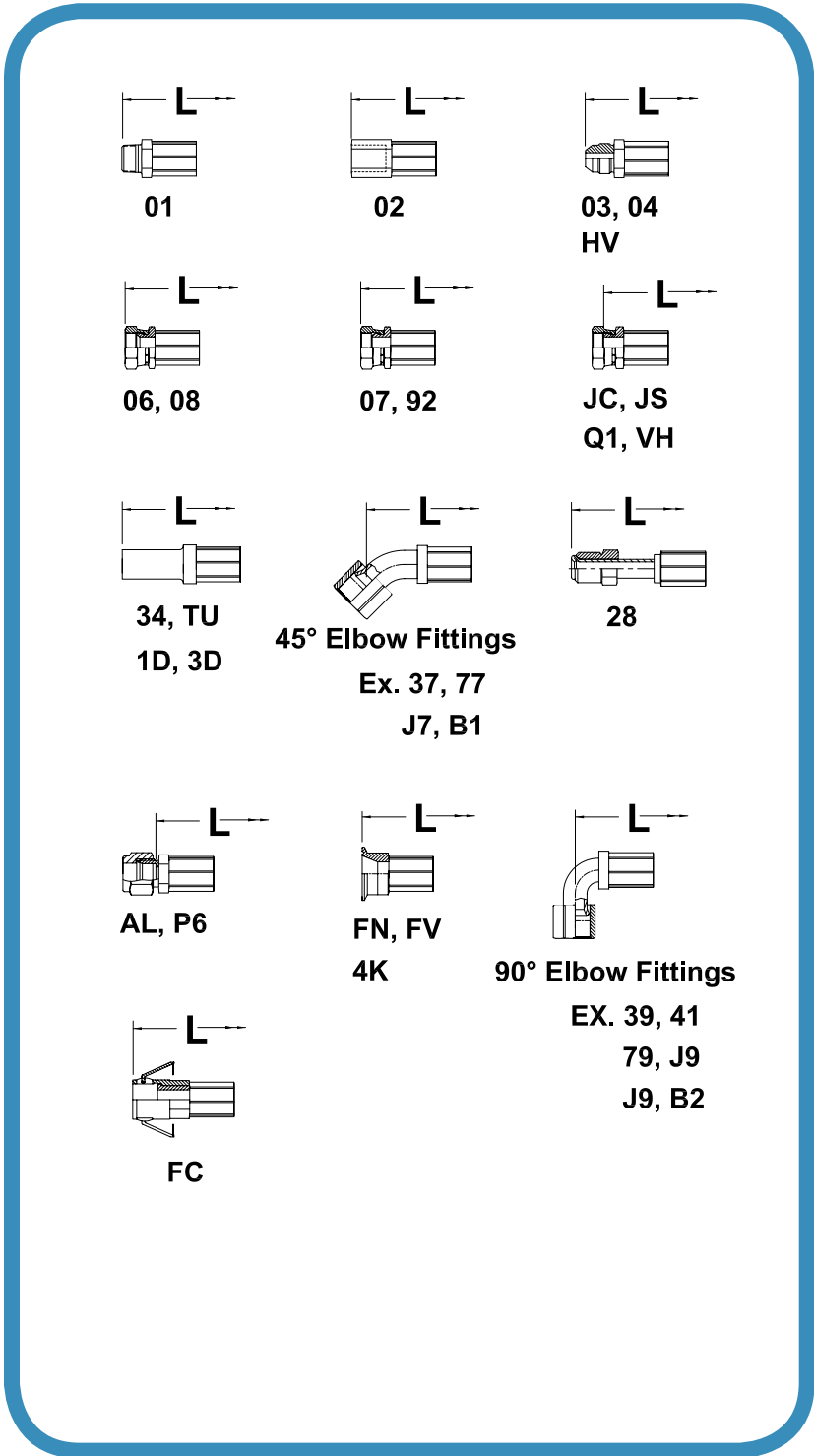



Summary of Properties

PTFE, FEP and PFA

The table below lists a generally accepted summary of properties that we believe to be reliable. Please note that many of these resins are produced in several varieties and property characteristics may vary. Therefore, determination of resin is dependent on the application and this table is only meant to serve as a general guideline.

Properties*	ASTM or Unit	PTFE	FEP	PFA	High Purity PFA
MECHANICAL PROPERTIES					
Specific Gravity	D792 D3307	2.13-2.22 -	2.12-2.17 -	2.12-2.17 -	- 2.14-2.16
Elongation %	D638 D3307	200-450 -	250-330 -	280-400 -	- 370
Tensile Strength (psi)	D638(psi) D3307(psi)	2000-7000 -	2800-4000 -	4000-5000 -	- 4693
Flexural Strength (psi)	D790	no break	no break	no break	no break
Compressive Strength (psi)	D695	700-900	725-2200	725-810	na
Tensile Elastic Modulus (Young's Modulus) (psi)	D638	57,000 -	50,000 -	72,500- 87,000	na
Flexural Modulus	D790(psi) D790 103MPa (103kgf/cm ²)	71,000-85,000 0.5-0.6 (5.0-6.0)	78,000-92,000 0.5-0.6 (5.5-6.4)	94,000-99,000 0.6-0.7 (6.6-7.0)	- 647-686 -
Flex Life (MIT cycles)	D2176	>1,000,000	5,000-80,000	10,000-500,000	2000 x 10 ³
Hardness Durometer Shore D	D2240	D50-65	D55	D55-D60	D60
Coefficient of Friction	(on steel)	0.02	0.05	0.04-0.06	0.05
Abrasion Resistance 1000 cycles	Taber	8-90	14-20	0.00-96.75	na
Impact Strength IZOD. 73°F/23°C notched ft/lbs/in	D256	3	no break	no break	no break
THERMAL PROPERTIES					
Melting Point	°C °F	327 621	260 500	305 582	305 582
Upper Service Temperature(20000h)	°C °F	260 500	204 400	260 500	260 500
Flammability	UL 94	V-0	V-0	V-0	V-0
Thermal Conductivity BTU-in/hr-ft ² , °F		1.7-2.08	1.4	1.3	na
Thermal Conductivity Cal-cm/sec-cm ² , °C		6 x 10 ⁻⁴	6 x 10 ⁻⁴	6 x 10 ⁻⁶	na
Linear Coefficient of Thermal Expansion Min/in°F 73.4-140°F	D696	55.6	46.1-58.3	66.7	na
Heat of Fusion	BTU/LB	29-37	4-35	13	na
Heat of Combustion	BTU/LB °F	2200	2200	2300	na
Low Temperature Embrittlement	°C °F	-268 -450	-268 -450	-268 -450	-268 -450
ELECTRICAL PROPERTIES					
Dielectric Constant	D150/10 ³ Hz D150/10 ⁶ Hz	2.1 2.1	2.1 2.1	2.1 2.1	2.1 2.1
Dielectric Strength	D149/125 MIL D149/10 MIL	500 ≥1400	508 >610	500 ≥1400	500 - 600 na
Volume Resistivity	D257/ohm-cm	>10 ¹⁸	>10 ¹⁸	>10 ¹⁸	na
Surface Resistivity	D257/ohm-cm	>10 ¹⁸	>10 ¹⁷	>10 ¹⁷	na
GENERAL PROPERTIES					
Chemical/Solvent Resistance	D543	Excellent	Excellent	Excellent	Excellent
Refractive Index		1.35	1.338	1.34	1.34
Limiting Oxygen Index, %	D2868	>95	>95	≥95	na
Water Contact Angle	Angle to Level	110	114	115	na
Water Absorption 24h,%	D570	<0.01	<0.01	<0.03	<0.01
Weatherability		Excellent	Excellent	Excellent	Excellent

*General resin properties; Tubing properties may vary.

Selection of Hose Diameter From Flow Rate and Velocity

The Fluid Velocity Nomogram gives the velocity of a liquid as a function of flow rate and inside diameter of the fluid line. The commonly recommended maximum velocities for hydraulic oil systems at 200°F or less are indicated for guidance.

Example: At 10 gpm, what is the minimum size within the recommended velocity range for a hydraulic pressure line?

The dashed line drawn from the 10 gpm mark on the left hand line to the maximum velocity of 20 fps intersects the middle line at .438" (7/16" I. D. hose or tubing). For a hose application, use 1/2" I. D., the nearest common standard size.

This chart is based on the following formulas:

$$v_{\text{fps}} = \frac{.321Q}{\frac{\pi d^2}{4}}$$

Q = gal per min
d = hose or tube I. D. (inch)

$$\text{cu. ft./min.} = .1337 Q$$

The cu. ft. per min. value is the actual volume flow rate under flowing conditions. For air, standard cfm of free air = 7.81 actual cfm when the inlet air is at 100 PSIG, 68°F.

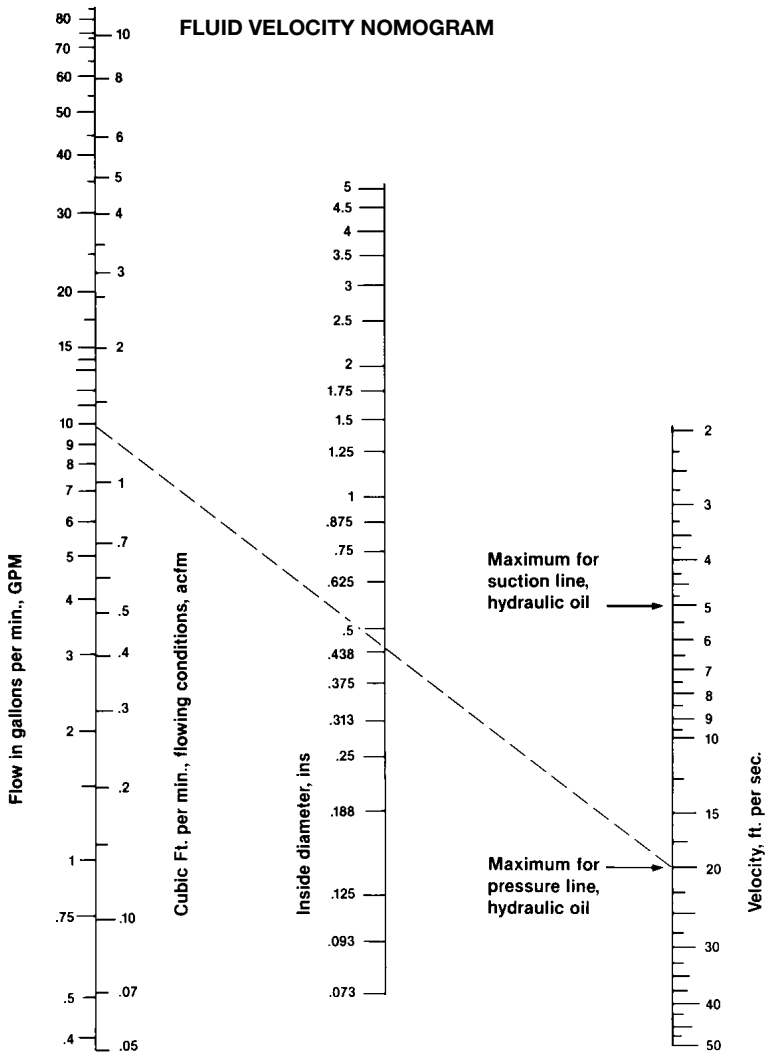



Standard Fitting Configurations by Connection and End Code

	Description	End Code	
Pipe	Male NPTF Pipe - Rigid - Straight	01	
	Male NPTF Pipe - Swivel - Straight	13	
	Male NPTF Pipe - Swivel - 90° Elbow	1L	
	Female NPTF Pipe - Rigid - Straight	02	
	Female NPSM Pipe - Swivel - Straight (60° Cone)	07	
SAE Str. Trd.	Male SAE Straight Thread with O-Ring - Rigid - Straight	05	
	Male SAE Straight Thread with O-Ring - Swivel - Straight	0G	
	Male SAE Straight Thread with O-Ring - Swivel - 90° Elbow	0L	
	Male SAE Straight Thread with O-Ring - Adjustable - 90° Elbow	35	
Flare	Male JIC 37° - Rigid - Straight	03	
	Male JIC 37° - Bulkhead without Locknut - Straight	LB	
	Female JIC 37° - Swivel - Straight	06	
	Female JIC 37° - Swivel - 45° Elbow - Short Drop	37	
	Female JIC 37° - Swivel - 45° Elbow - Medium Drop	L7	
	Female JIC 37° - Swivel - 90° Elbow - Short Drop	39	
	Female JIC 37° - Swivel - 90° Elbow - Medium Drop	L9	
	Female JIC 37° - Swivel - 90° Elbow - Long Drop	41	
	Male SAE 45° - Rigid - Straight	04	
	Female SAE 45° - Swivel - Straight	08	
	Female SAE 45 / Swivel - 45° Elbow	77	
	Female SAE 45 / Swivel - 90° Elbow	79	
	Female SAE 45 / Swivel - 90° Elbow - Long Drop	81	
	Female JIC 37°/SAE 45° Dual Flare - Swivel - Straight	06	
	Inverted Flare	Male Inverted SAE 45° - Swivel - Straight	28
		Male Inverted SAE 45° - Swivel - 45° Elbow	67
Male Inverted SAE 45° - Swivel - 90° Elbow		69	
Female Inverted SAE 45° - Rigid - Straight		29	
Seal-Lok	Male Seal-Lok - Rigid - Straight (with O-Ring)	J0	
	Male Seal-Lok - Bulkhead without Locknut-Straight (with O-Ring)	JB	
	Female Seal-Lok - Swivel - Straight - Long	JS	
	Female Seal-Lok - Swivel - Straight - Short	JC	
	Female Seal-Lok - Swivel - 221/2° Elbow	J6	
	Female Seal-Lok - Swivel - 45° Elbow	J7	
	Female Seal-Lok - Swivel - 90° Elbow - Short Drop	J9	
	Female Seal-Lok - Swivel - 90° Elbow - Medium Drop	J5	
	Female Seal-Lok - Swivel - 90° Elbow - Long Drop	J1	
JIS	Female Metric Swivel - Straight (30° Flare)	MU	
	Female BSP Parallel Pipe - Swivel - Straight (30° Flare)	FU	
	Male BSP Taper Pipe - Rigid - Straight (60° Cone)	UT	
	Female BSP Parallel Pipe - Swivel - Straight (60° Cone)	GU	
	Female BSP Parallel Pipe - Swivel - 45° Elbow (60° Cone)	G1	
	Female BSP Parallel Pipe - Swivel - 90° Elbow (60° Cone)	G2	
Metric	Male Metric L - Rigid - Straight (24° Cone)	D0	
	Male Standpipe Metric L - Rigid - Straight	1D	
	Female Metric L - Swivel - Straight (Ball Nose)	C3	

	Description	End Code
Metric	Female Metric L - Swivel - 45° Elbow (Ball Nose)	C4
	Female Metric L - Swivel - 90° Elbow (Ball Nose)	C5
	Female Metric L - Swivel - Straight (24° Cone with O-Ring)	CA
	Female Metric L - Swivel - 45° Elbow (24° Cone with O-Ring)	CE
	Female Metric L - Swivel - 90° Elbow (24° Cone with O-Ring) -	CF
	Male Metric S - Rigid - Straight (24° Cone)	D2
	Male Standpipe Metric S - Rigid - Straight	3D
	Female Metric S - Swivel - Straight (Ball Nose)	C6
	Female Metric S - Swivel - 45° Elbow (Ball Nose)	C7
	Female Metric S - Swivel - 90° Elbow (Ball Nose)	C8
BSP	Female Metric S - Swivel - Straight (24° Cone with O-Ring)	C9
	Female Metric S - Swivel - 45° Elbow (24° Cone with O-Ring)	0C
	Female Metric S - Swivel - 90° Elbow (24° Cone with O-Ring)	1C
	Male BSP Taper Pipe - Rigid - Straight	91
	Female BSP Parallel Pipe - Swivel - Straight (60° Cone)	92
	Male BSP Parallel Pipe - Rigid - Straight (60° Cone)	D9
	Female BSP Parallel Pipe - Swivel - 45° Elbow (60° Cone)	B1
	Female BSP Parallel Pipe - Swivel - 90° Elbow (60° Cone)	B2
	Female BSP Parallel Pipe - Swivel - 90° Elbow Block Type (60° Cone)	B4
	Female BSP Parallel Pipe - Swivel - Straight (Flat Seat)	B5
Fr. Gaz	Male BSP Taper Pipe - Rigid - 45° Elbow	BV
	Male BSP Taper Pipe - Rigid - 90° Elbow or Side Outlet	BZ
	Male French Gaz Series - Rigid - Straight (24° Cone)	FG
	Female French Gaz Series - Swivel - Straight (Ball Nose)	F4
	DIN Metric Banjo - Straight	49
	Male Standpipe - Rigid - Straight (Inch Size Tube O.D.)	34
	Male Standpipe - Rigid - Straight with V-Notch	TW
	Male Ferulok Flareless-Rigid-Straight (24° Cone with Nut & Ferrule)	11
	Female Ferulok Flareless - Swivel - Straight (24° Cone)	12
	Male Rapid Assembly, Straight	WU
Male Rapid Assembly, 45° Elbow	WW	
Specialty	Male Rapid Assembly, 90° Elbow	WY
	Bulkhead w/Zerk Port Integrated	GK
	Female A-Lok® Compression	AL
	Female Cam & Groove	FC
	Flange Retainer	4K
	Male I-Line® Sanitary	H1
	Female I-Line® Sanitary	H2
	Male Sanitary Bevel Seat	H4
	Female Sanitary Bevel Seat	H5
	Sanitary Flange & Step Downs	FN
Mini Sanitary Flange	FV	

Hose Assembly & Crimping

Permanent Fittings - 91N/91 Series

1 Cut

Using a power hose cutoff saw, cut hose squarely.



NOTE

PTFE Hose should be taped prior to cutting. Hose should be cut at center point of taped section.

2 Inspection

Hose – Visually inspect both ends of hose for square cut. Remove any burrs, loose fibers or wires.



Fittings – Verify fitting series corresponds to the selected hose. Visually inspect fitting(s) for a through-hole, threads and damage.

3 Prep Assembly

Insertion Depth – Mark hose end with proper insertion depth line. See Hose Fitting Insertion Values, page 46, for insertion depths of fitting series that do not incorporate an insertion depth. For jacketed PTFE hoses, use a sharp knife and light pressure to cut back the cover at least the length of the insertion depth of the fitting.

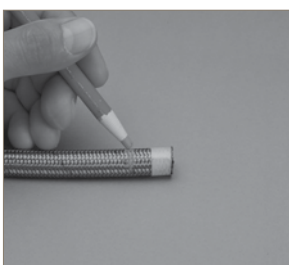

WARNING

Do not use lubricating oil when installing fittings on hose used in oxygen service. When installing fittings on hose used in oxygen service, lubricate with a non-oil based soap solution. Failure to do so may result in an explosion and personal injury when hose is used.



Assemble hose – Push fitting onto hose slightly and then remove tape. Continue pushing fitting onto hose until fitting reaches depth insertion mark.



Hose Assembly & Crimping

Permanent Fittings - 91N/91 Series

4 Die Selection

Select proper Parkrimp die set. (Reference Crimpsource online at www.parker.com/crimpsource)



5 Lubricate Bowl

Using a premium, quality, lithium-base grease, apply a thin layer of grease on bowl of crimper base plate.



6 Die & Spacer Ring

Crimp Die – Place die set into bowl.



Die Ring – Place applicable die ring on top of die. Position ring so it is centered on die.



7 Crimp

Assemble hose – Insert hose and fitting from bottom of crimper and up through die set. Position fitting so bottom of fitting skirt rests on die step (PARKALIGN® feature).



WARNING

Keep fingers and hands away from die-pusher area. Failure to do so may result in personal injury.

NOTE

Pump on crimper must not exceed the rated pressure of the crimper being used. Parker Hannifin will not accept responsibility for the operation of or provide warranty coverage for a crimper that is operated by a power unit other than equipment supplied by Parker Hannifin for the express purpose of operating the crimper.

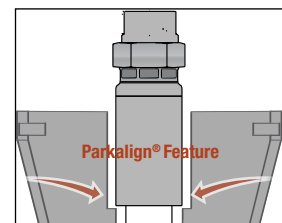

While holding hose and fitting in position on die step, crimp fitting onto hose until die ring contacts base plate.

Hose Assembly & Crimping

Permanent Fittings - 91N/91 Series

8 Measure & Inspect

Crimp Die – Place die set into bowl.



Measure and verify hose assembly length.



Inspect insertion depth mark at fitting ends. Insertion mark must be visible but not exceed 1/8" from end of crimped fitting shell.



Measure crimp diameter of each fitting at top, middle and bottom of shell. Take measurements at a minimum of three places around shell circumference. Verify crimp diameter is within tolerances at www.parker.com/crimpsource



Hose Assembly & Crimping

Field Attachable - 90 Series

1 Inspection

Hose – Visually inspect both ends of hose for square cut. Remove any burrs, loose fibers or wires.



Fittings – Inspect each component for possible damage. In addition, inspect socket and nipple for a through-hole and threads.



2 Assembly

Slide two sockets over end of hose with bottom of sockets back to back. Position sockets at each end of hose.



NOTE

When installing sockets on hose, check hose ends to determine if wire braid “necks down” (bends inward). If one end “necks down” use this end to slide sockets onto hose.



3 Assembly

Mount nipple hex in vise. Ensure nipple end extends beyond vise jaws sufficiently to allow installation of hose.



Push hose bore onto nipple to size tube and to aid in separating braid before assembling ferrule onto hose.

Once completed, remove hose from nipple.



Hose Assembly & Crimping

Field Attachable - 90 Series

4 Assembly

By hand, push sleeve over end of PTFE core tube and under wire braid.



To complete positioning of sleeve, push hose end with sleeve, against a solid flat surface.



5 Assembly

Verify tube butts against inside shoulder of ferrule.



Using a tapered punch, push punch into end of sleeve and tube to set sleeve barbs into tube.



6 Assembly

Using SAE 20 weight oil, lubricate nipple and socket threads. For stainless steel fittings, use Parker ThreadMate™ or a molybdenum type lubricant.



WARNING

Do not use lubricating oil when installing fittings on hose used in oxygen service. When installing fittings on hose used in oxygen service lubricate with a non-oil based soap solution. Failure to do so may result in an explosion and personal injury when hose is used.



Assemble hose – Using a twisting motion, push hose over nipple until hose is seated against nipple chamfer.

Hose Assembly & Crimping

Field Attachable - 90 Series

7 Assembly

Push socket forward and hand-start threading of socket to nipple.



CAUTION

When tightening socket in vise, do not over tighten vise jaws. Over tightening vise jaws will distort internal threads of socket.



Remove assembly from vise and reposition with socket in vise jaws. Ensure socket extends beyond vise jaws far enough to allow nipple to be completely tightened.

8 Assembly

Wrench tighten nipple hex until clearance between hex and socket hex is 1/32" or less.



Tighten further to align corners of nipple and socket hexes if necessary.



9 Measure & Inspect

Measure and verify hose assembly length.





WARNING: Failure or improper selection or improper use of hose, tubing, fittings, assemblies or related accessories ("Products") can cause death, personal injury and property damage. Possible consequences of failure or improper selection or improper use of these Products include but are not limited to:

- Fittings thrown off at high speed.
- High velocity fluid discharge.
- Explosion or burning of the conveyed fluid.
- Electrocutation from high voltage electric powerlines.
- Contact with suddenly moving or falling objects that are controlled by the conveyed fluid.

- Injections by high-pressure fluid discharge.
- Dangerously whipping Hose.
- Contact with conveyed fluids that may be hot, cold, toxic or otherwise injurious.
- Sparking or explosion caused by static electricity buildup or other sources of electricity.
- Sparking or explosion while spraying paint or flammable liquids.
- Injuries resulting from inhalation, ingestion or exposure to fluids.

Before selecting or using any of these Products, it is important that you read and follow the instructions below. Only Hose from Parker's Stratoflex Products Division is approved for in flight aerospace applications.

1.0 GENERAL INSTRUCTIONS

1.1 Scope: This safety guide provides instructions for selecting and using (including assembling, installing, and maintaining) these Products. For convenience, all rubber and/or thermoplastic products commonly called "hose" or "tubing" are called "Hose" in this safety guide. All assemblies made with Hose are called "Hose Assemblies". All products commonly called "fittings", "couplings" or "adapters" are called "Fittings". All related accessories (including crimping and swaging machines and tooling) are called "Related Accessories". This safety guide is a supplement to and is to be used with the specific Parker publications for the specific Hose, Fittings and Related Accessories that are being considered for use. Parker publications are available at www.parker.com. SAE J1273 (www.sae.org) and ISO 17165 2 (www.ansi.org) also provide recommended practices for hydraulic Hose Assemblies.

1.2 Fail-Safe: Hose, Hose Assemblies and Fittings can and do fail without warning for many reasons. Design all systems and equipment in a fail safe mode, so that failure of the Hose, Hose Assembly or Fitting will not endanger persons or property.

1.3 Distribution: Provide a copy of this safety guide to each person responsible for selecting or using Hose and Fitting products. Do not select or use Parker Hose or Fittings without thoroughly reading and understanding this safety guide as well as the specific Parker publications for the Products.

1.4 User Responsibility: Due to the wide variety of operating conditions and applications for Hose and Fittings, Parker does not represent or warrant that any particular Hose or Fitting is suitable for any specific end use system. This safety guide does not analyze all technical parameters that must be considered in selecting a product. The user, through its own analysis and testing, is solely responsible for:

- Making the final selection of the Products.
- Assuring that the user's requirements are met and that the application presents no health or safety hazards.
- Providing all appropriate health and safety warnings on the equipment on which the Products are used.
- Assuring compliance with all applicable government and industry standards.

1.5 Additional Questions: Call the appropriate Parker technical service department if you have any questions or require any additional information. See the Parker publication for the Products being considered or used, or call 1 800 CPARKER, or go to www.parker.com, for telephone numbers of the appropriate technical service department.

2.0 HOSE AND FITTING SELECTION INSTRUCTIONS

2.1 Electrical Conductivity: Certain applications require that the Hose be nonconductive to prevent electrical current flow. Other applications require the Hose and the Fittings and the Hose/Fitting interface to be sufficiently conductive to drain off static electricity. Extreme care must be exercised when selecting Hose and Fittings for these or any other applications in which electrical conductivity or nonconductivity is a factor.

The electrical conductivity or nonconductivity of Hose and Fittings is dependent upon many factors and may be susceptible to change. These factors include but are not limited to the various materials used to make the Hose and the Fittings, Fitting finish (some Fitting finishes are electrically conductive while others are nonconductive), manufacturing methods (including moisture control), how the Fittings contact the Hose, age and amount of deterioration or damage or other changes, moisture content of the Hose at any particular time, and other factors.

The following are considerations for electrically nonconductive and conductive Hose. For other applications consult the individual catalog pages and the appropriate industry or regulatory standards for proper selection.

2.1.1 Electrically Nonconductive Hose: Certain applications require that the Hose be nonconductive to prevent electrical current flow or to maintain electrical

isolation. For applications that require Hose to be electrically nonconductive, including but not limited to applications near high voltage electric lines, only special nonconductive Hose can be used. The manufacturer of the equipment in which the nonconductive Hose is to be used must be consulted to be certain that the Hose and Fittings that are selected are proper for the application. Do not use any Parker Hose or Fittings for any such application requiring nonconductive Hose, including but not limited to applications near high voltage electric lines, unless (i) the application is expressly approved in the Parker technical publication for the product, (ii) the Hose is marked "nonconductive", and (iii) the manufacturer of the equipment on which the Hose is to be used specifically approves the particular Parker Hose and Fittings for such use.

2.1.2 Electrically Conductive Hose: Parker manufactures special Hose for certain applications that require electrically conductive Hose.

Parker manufactures special Hose for conveying paint in airless paint spraying applications. This Hose is labeled "Electrically Conductive Airless Paint Spray Hose" on its layline and packaging. This Hose must be properly connected to the appropriate Parker Fittings and properly grounded in order to dissipate dangerous static charge buildup, which occurs in all airless paint spraying applications. Do not use any other Hose for airless paint spraying, even if electrically conductive. Use of any other Hose or failure to properly connect the Hose can cause a fire or an explosion resulting in death, personal injury, and property damage.

Parker manufactures a special Hose for certain compressed natural gas ("CNG") applications where static electricity buildup may occur. Parker CNG Hose assemblies comply with the requirements of ANSI/IAS NGV 4.2-1999; CSA 12.52-M99, "Hoses for Natural Gas Vehicles and Dispensing Systems" (www.ansi.org). This Hose is labeled "Electrically Conductive for CNG Use" on its layline and packaging. This Hose must be properly connected to the appropriate Parker Fittings and properly grounded in order to dissipate dangerous static charge buildup, which occurs in, for example, high velocity CNG dispensing or transfer. Do not use any other Hose for CNG applications where static charge buildup may occur, even if electrically conductive. Use of other Hoses in CNG applications or failure to properly connect or ground this Hose can cause a fire or an explosion resulting in death, personal injury, and property damage. Care must also be taken to protect against CNG permeation through the Hose wall. See section 2.6, Permeation, for more information. Parker CNG Hose is intended for dispenser and vehicle use at a maximum temperature of 180°F (82°C). Parker CNG Hose should not be used in confined spaces or unventilated areas or areas exceeding 180°F (82°C). Final assemblies must be tested for leaks. CNG Hose Assemblies should be tested on a monthly basis for conductivity per ANSI/IAS NGV 4.2-1999; CSA 12.52-M99.

Parker manufactures special Hose for aerospace in flight applications. Aerospace in flight applications employing Hose to transmit fuel, lubricating fluids and hydraulic fluids require a special Hose with a conductive inner tube. This Hose for in flight applications is available only from Parker's Stratoflex Products Division. Do not use any other Parker Hose for in flight applications, even if electrically conductive. Use of other Hoses for in flight applications or failure to properly connect or ground this Hose can cause a fire or an explosion resulting in death, personal injury and property damage. These Hose assemblies for in flight applications must meet all applicable aerospace industry, aircraft engine and aircraft requirements.

2.2 Pressure: Hose selection must be made so that the published maximum working pressure of the Hose and Fittings are equal to or greater than the maximum system pressure. The maximum working pressure of a Hose Assembly is the lower of the respective published maximum working pressures of the Hose and the Fittings used. Surge pressures or peak transient pressures in the system must be below the published maximum working pressure for the Hose. Surge pressures and peak pressures can usually only be determined by sensitive electrical instrumentation that measures and indicates pressures at millisecond intervals. Mechanical pressure gauges indicate only average pressures and can not be used to determine surge pressures or peak transient pressures. Published burst pressure ratings for Hose is for manufacturing test



Safety Guide

no indication that the Product can be used in applications at the burst pressure or otherwise above the published maximum recommended working pressure.

2.3 Suction: Hoses used for suction applications must be selected to insure that the Hose will withstand the vacuum and pressure of the system. Improperly selected Hose may collapse in suction application.

2.4 Temperature: Be certain that fluid and ambient temperatures, both steady and transient, do not exceed the limitations of the Hose. Temperatures below and above the recommended limit can degrade Hose to a point where a failure may occur and release fluid. Properly insulate and protect the Hose Assembly when routing near hot objects (e.g. manifolds). Do not use any Hose in any application where failure of the Hose could result in the conveyed fluids (or vapors or mist from the conveyed fluids) contacting any open flame, molten metal, or other potential fire ignition source that could cause burning or explosion of the conveyed fluids or vapors.

2.5 Fluid Compatibility: Hose Assembly selection must assure compatibility of the Hose tube, cover, reinforcement, and Fittings with the fluid media used. See the fluid compatibility chart in the Parker publication for the product being considered or used. This information is offered only as a guide. Actual service life can only be determined by the end user by testing under all extreme conditions and other analysis. Hose that is chemically compatible with a particular fluid must be assembled using Fittings and adapters containing likewise compatible seals.

2.6 Permeation: Permeation (that is, seepage through the Hose) will occur from inside the Hose to outside when Hose is used with gases, liquid and gas fuels, and refrigerants (including but not limited to such materials as helium, diesel fuel, gasoline, natural gas, or LPG). This permeation may result in high concentrations of vapors which are potentially flammable, explosive, or toxic, and in loss of fluid. Dangerous explosions, fires, and other hazards can result when using the wrong Hose for such applications. The system designer must take into account the fact that this permeation will take place and must not use Hose if this permeation could be hazardous. The system designer must take into account all legal, government, insurance, or any other special regulations which govern the use of fuels and refrigerants. Never use a Hose even though the fluid compatibility is acceptable without considering the potential hazardous effects that can result from permeation through the Hose Assembly.

Permeation of moisture from outside the Hose to inside the Hose will also occur in Hose assemblies, regardless of internal pressure. If this moisture permeation would have detrimental effects (particularly, but not limited to refrigeration and air conditioning systems), incorporation of sufficient drying capacity in the system or other appropriate system safeguards should be selected and used.

2.7 Size: Transmission of power by means of pressurized fluid varies with pressure and rate of flow. The size of the components must be adequate to keep pressure losses to a minimum and avoid damage due to heat generation or excessive fluid velocity.

2.8 Routing: Attention must be given to optimum routing to minimize inherent problems (kinking or flow restriction due to Hose collapse, twisting of the Hose, proximity to hot objects or heat sources). For additional routing recommendations see SAE J1273 and ISO 17165-2. Hose Assemblies have a finite life and if possible, should be installed in a manner that allows for ease of inspection and future replacement. Rubber Hose because of its relative short life, should not be used in residential and commercial buildings for HVAC (heating, ventilating and air conditioning) applications.

2.9 Environment: Care must be taken to insure that the Hose and Fittings are either compatible with or protected from the environment (that is, surrounding conditions) to which they are exposed. Environmental conditions including but not limited to ultraviolet radiation, sunlight, heat, ozone, moisture, water, salt water, chemicals and air pollutants can cause degradation and premature failure.

2.10 Mechanical Loads: External forces can significantly reduce Hose life or cause failure. Mechanical loads which must be considered include excessive flexing, twist, kinking, tensile or side loads, bend radius, and vibration. Use of swivel type Fittings or adapters may be required to insure no twist is put into the Hose. Unusual applications may require special testing prior to Hose selection.

2.11 Physical Damage: Care must be taken to protect Hose from wear, snagging, kinking, bending smaller than minimum bend radius and cutting, any of which can cause premature Hose failure. Any Hose that has been kinked or bent to a radius smaller than the minimum bend radius, and any Hose that has been cut or is cracked or is otherwise damaged should be removed and discarded.

2.12 Proper End Fitting: See instructions 3.2 through 3.5. These recommendations may be substantiated by testing to industry standards such as SAE J517 for hydraulic applications, or MIL-A-5070, AS1339, or AS3517 for Hoses from Parker's Stratoflex Products Division for aerospace applications.

2.13 Length: When establishing a proper Hose length, motion absorption, Hose length changes due to pressure, and Hose and machine tolerances and movement must be considered.

2.15 Hose Cleanliness: Hose components may vary in cleanliness levels. Care must be taken to insure that the Hose Assembly selected has an adequate level of cleanliness for the application.

2.16 Fire Resistant Fluids: Some fire resistant fluids that are to be conveyed by Hose require use of the same type of Hose as used with petroleum base fluids. Some such fluids require a special Hose, while a few fluids will not work with any Hose at all. See instructions 2.5 and 1.5. The wrong Hose may fail after a very short service. In addition, all liquids but pure water may burn fiercely under certain conditions, and even pure water leakage may be hazardous.

2.17 Radiant Heat: Hose can be heated to destruction without contact by such nearby items as hot manifolds or molten metal. The same heat source may then initiate a fire. This can occur despite the presence of cool air around the Hose.

2.18 Welding or Brazing: When using a torch or arc welder in close proximity to hydraulic lines, the hydraulic lines should be removed or shielded with appropriate fire resistant materials. Flame or weld spatter could burn through the Hose and possibly ignite escaping fluid resulting in a catastrophic failure. Heating of plated parts, including Hose Fittings and adapters, above 450°F (232°C) such as during welding, brazing or soldering may emit deadly gases.

2.19 Atomic Radiation: Atomic radiation affects all materials used in Hose assemblies. Since the long-term effects may be unknown, do not expose Hose assemblies to atomic radiation.

2.20 Aerospace Applications: The only Hose and Fittings that may be used for in flight aerospace applications are those available from Parker's Stratoflex Products Division. Do not use any other Hose or Fittings for in flight applications. Do not use any Hose or Fittings from Parker's Stratoflex Products Division with any other Hose or Fittings, unless expressly approved in writing by the engineering manager or chief engineer of Stratoflex Products Division and verified by the user's own testing and inspection to aerospace industry standards.

2.21 Unlocking Couplings: Ball locking couplings or other Fittings with quick disconnect ability can unintentionally disconnect if they are dragged over obstructions, or if the sleeve or other disconnect member, is bumped or moved enough to cause disconnect. Threaded Fittings should be considered where there is a potential for accidental uncoupling.

3.0 HOSE AND FITTING ASSEMBLY AND INSTALLATION INSTRUCTIONS

3.1 Component Inspection: Prior to assembly, a careful examination of the Hose and Fittings must be performed. All components must be checked for correct style, size, catalog number, and length. The Hose must be examined for cleanliness, obstructions, blisters, cover looseness, kinks, cracks, cuts or any other visible defects. Inspect the Fitting and sealing surfaces for burrs, nicks, corrosion or other imperfections. Do NOT use any component that displays any signs of nonconformance.

3.2 Hose and Fitting Assembly: Do not assemble a Parker Fitting on a Parker Hose that is not specifically listed by Parker for that Fitting, unless authorized in writing by the engineering manager or chief engineer of the appropriate Parker division. Do not assemble a Parker Fitting on another manufacturer's

Hose or a Parker Hose on another manufacturer's Fitting unless (i) the engineering manager or chief engineer of the appropriate Parker division approves the Assembly in writing or that combination is expressly approved in the appropriate Parker literature for the specific Parker product, and (ii) the user verifies the Assembly and the application through analysis and testing. For Parker Hose that does not specify a Parker Fitting, the user is solely responsible for the selection of the proper Fitting and Hose Assembly procedures. See instruction 1.4.

To prevent the possibility of problems such as leakage at the Fitting or system contamination, it is important to completely remove all debris from the cutting operation before installation of the Fittings. The Parker published instructions must be followed for assembling the Fittings on the Hose. These instructions are provided in the Parker Fitting catalog for the specific Parker Fitting being used, or by calling 1 800 CPARKER, or at www.parker.com.

3.3 Related Accessories: Do not crimp or swage any Parker Hose or Fitting with anything but the listed swage or crimp machine and dies in accordance with Parker published instructions. Do not crimp or swage another manufacturer's Fitting with a Parker crimp or swage die unless authorized in writing by the engineering manager or chief engineer of the appropriate Parker division.

3.4 Parts: Do not use any Parker Fitting part (including but not limited to socket, shell, nipple, or insert) except with the correct Parker mating parts, in accordance with Parker published instructions, unless authorized in writing by the engineering manager or chief engineer of the appropriate Parker division.

3.5 Field Attachable/Permanent: Do not reuse any field attachable Hose Fitting that has blown or pulled off a Hose. Do not reuse a Parker permanent Hose Fitting

(crimped or swaged) or any part thereof. Complete Hose Assemblies may only be reused after proper inspection under section 4.0. Do not assemble Fittings to any previously used hydraulic Hose that was in service, for use in a fluid power application.

3.6 Pre-Installation Inspection: Prior to installation, a careful examination of the Hose Assembly must be performed. Inspect the Hose Assembly for any damage or defects. DO NOT use any Hose Assembly that displays any signs of nonconformance.

3.7 Minimum Bend Radius: Installation of a Hose at less than the minimum listed bend radius may significantly reduce the Hose life. Particular attention must be given to preclude sharp bending at the Hose to Fitting juncture. Any bending during installation at less than the minimum bend radius must be avoided. If any Hose is kinked during installation, the Hose must be discarded.

3.8 Twist Angle and Orientation: Hose Assembly installation must be such that relative motion of machine components does not produce twisting.

3.9 Securement: In many applications, it may be necessary to restrain, protect, or guide the Hose to protect it from damage by unnecessary flexing, pressure surges, and contact with other mechanical components. Care must be taken to insure such restraints do not introduce additional stress or wear points.

3.10 Proper Connection of Ports: Proper physical installation of the Hose Assembly requires a correctly installed port connection insuring that no twist or torque is transferred to the Hose when the Fittings are being tightened or otherwise during use..

3.11 External Damage: Proper installation is not complete without insuring that tensile loads, side loads, kinking, flattening, potential abrasion, thread damage or damage to sealing surfaces are corrected or eliminated. See instruction 2.10.

3.12 System Checkout: All air entrapment must be eliminated and the system pressurized to the maximum system pressure (at or below the Hose maximum working pressure) and checked for proper function and freedom from leaks. Personnel must stay out of potential hazardous areas while testing and using.

3.13 Routing: The Hose Assembly should be routed in such a manner so if a failure does occur, the escaping media will not cause personal injury or property damage. In addition, if fluid media comes in contact with hot surfaces, open flame or sparks, a fire or explosion may occur. See section 2.4.

3.14 Ground Fault Equipment Protection Devices (GFEPDs): WARNING! Fire and Shock Hazard: To minimize the danger of fire if the heating cable of a Multitube bundle is damaged or improperly installed, use a Ground Fault Equipment Protection Device. Electrical fault currents may be insufficient to trip a conventional circuit breaker.

For ground fault protection, the IEEE 515:1989 (www.ansi.org) standard for heating cables recommends the use of GFEPDs with a nominal 30 milliampere trip level for "piping systems in classified areas, those areas requiring a high degree of maintenance, or which may be exposed to physical abuse or corrosive atmospheres".

4.0 HOSE AND FITTING MAINTENANCE AND REPLACEMENT INSTRUCTIONS

4.1 Even with proper selection and installation, Hose life may be significantly reduced without a continuing maintenance program. The severity of the application, risk potential from a possible Hose failure, and experience with any Hose failures in the application or in similar applications should determine the frequency of the inspection and the replacement for the Products so that Products are replaced before any failure occurs. A maintenance program must be established and followed by the user and, at minimum, must include instructions 4.2 through 4.7.

4.2 Visual Inspection Hose/Fitting: Any of the following conditions require immediate shut down and replacement of the Hose Assembly:

- Fitting slippage on Hose;
- Damaged, cracked, cut or abraded cover (any reinforcement exposed);
- Hard, stiff, heat cracked, or charred Hose;
- Cracked, damaged, or badly corroded Fittings;
- Leaks at Fitting or in Hose;
- Kinked, crushed, flattened or twisted Hose; and
- Blistered, soft, degraded, or loose cover.

4.3 Visual Inspection All Other: The following items must be tightened, repaired, corrected or replaced as required:

- Leaking port conditions;
- Excess dirt buildup;
- Worn clamps, guards or shields; and
- System fluid level, fluid type, and any air entrapment.

4.4 Functional Test: Operate the system at maximum operating pressure and check for possible malfunctions and leaks. Personnel must avoid potential hazardous areas while testing and using the system. See section 2.2.

4.5 Replacement Intervals: Hose assemblies and elastomeric seals used on Hose Fittings and adapters will eventually age, harden, wear and deteriorate under thermal cycling and compression set. Hose Assemblies and elastomeric seals should be inspected and replaced at specific replacement intervals, based on previous service life, government or industry recommendations, or when failures could result in unacceptable downtime, damage, or injury risk. See section 1.2. Hose and Fittings may be subjected to internal mechanical and/or chemical wear from the conveying fluid and may fail without warning. The user must determine the product life under such circumstances by testing. Also see section 2.5. See section 1.2.

4.6 Hose Inspection and Failure: Hydraulic power is accomplished by utilizing high pressure fluids to transfer energy and do work. Hoses, Fittings and Hose Assemblies all contribute to this by transmitting fluids at high pressures. Fluids under pressure can be dangerous and potentially lethal and, therefore, extreme caution must be exercised when working with fluids under pressure and handling the Hoses transporting the fluids. From time to time, Hose Assemblies will fail if they are not replaced at proper time intervals. Usually these failures are the result of some form of misapplication, abuse, wear or failure to perform proper maintenance. When Hoses fail, generally the high pressure fluids inside escape in a stream which may or may not be visible to the user. Under no circumstances should the user attempt to locate the leak by "feeling" with their hands or any other part of their body. High pressure fluids can and will penetrate the skin and cause severe tissue damage and possibly loss of limb. Even seemingly minor hydraulic fluid injection injuries must be treated immediately by a physician with knowledge of the tissue damaging properties of hydraulic fluid.

If a Hose failure occurs, immediately shut down the equipment and leave the area until pressure has been completely released from the Hose Assembly. Simply shutting down the hydraulic pump may or may not eliminate the pressure in the Hose Assembly. Many times check valves, etc., are employed in a system and can cause pressure to remain in a Hose Assembly even when pumps or equipment are not operating. Tiny holes in the Hose, commonly known as pinholes, can eject small, dangerously powerful but hard to see streams of hydraulic fluid. It may take several minutes or even hours for the pressure to be relieved so that the Hose Assembly may be examined safely.

Once the pressure has been reduced to zero, the Hose Assembly may be taken off the equipment and examined. It must always be replaced if a failure has occurred. Never attempt to patch or repair a Hose Assembly that has failed. Consult the nearest Parker distributor or the appropriate Parker division for Hose Assembly replacement information.

Never touch or examine a failed Hose Assembly unless it is obvious that the Hose no longer contains fluid under pressure. The high pressure fluid is extremely dangerous and can cause serious and potentially fatal injury.

4.7 Elastomeric seals: Elastomeric seals will eventually age, harden, wear and deteriorate under thermal cycling and compression set. Elastomeric seals should be inspected and replaced.

4.8 Refrigerant gases: Special care should be taken when working with refrigeration systems. Sudden escape of refrigerant gases can cause blindness if the escaping gases contact the eye and can cause freezing or other severe injuries if it contacts any other portion of the body.

4.9 Compressed natural gas (CNG): Parker CNG Hose Assemblies should be tested after installation and before use, and at least on a monthly basis per ANSI/IAS NGV 4.2-1999; CSA 12.52-M99 Section 4.2 "Visual Inspection Hose/Fitting". The recommended procedure is to pressurize the Hose and check for leaks and to visually inspect the Hose for damage.

Caution: Matches, candles, open flame or other sources of ignition shall not be used for Hose inspection. Leak check solutions should be rinsed off after use.

5.0 HOSE STORAGE

5.1 Age Control: Hose and Hose Assemblies must be stored in a manner that facilitates age control and first-in and first-out usage based on manufacturing date of the Hose and Hose Assemblies. The shelf life of rubber Hose or Hose Assemblies that have passed visual inspection and a proof test is 10 years (40 quarters) from the date of manufacture. The shelf life of thermoplastic and polytetrafluoroethylene Hose or Hose Assemblies is considered to be unlimited.

5.2 Storage: Stored Hose and Hose Assemblies must not be subjected to damage that could reduce their expected service life and must be placed in a cool, dark and dry area with the ends capped. Stored Hose and Hose Assemblies must not be exposed to temperature extremes, ozone, oils, corrosive liquids or fumes, solvents, high humidity, rodents, insects, ultraviolet light, electromagnetic fields or radioactive materials.



Offer of Sale

The items described in this document and other documents and descriptions provided by Parker Hannifin Corporation, its subsidiaries and its authorized distributors ("Seller") are hereby offered for sale at prices to be established by Seller. This offer and its acceptance by any customer ("Buyer") shall be governed by all of the following Terms and Conditions. Buyer's order for any item described in its document, when communicated to Seller verbally, or in writing, shall constitute acceptance of this offer. All goods, services or work described will be referred to as "Products".

1. Terms and Conditions. Seller's willingness to offer Products, or accept an order for Products, to or from Buyer is subject to these Terms and Conditions or any newer version of the terms and conditions found on-line at www.parker.com/saleterms/. Seller objects to any contrary or additional terms or conditions of Buyer's order or any other document issued by Buyer.

2. Price Adjustments; Payments. Prices stated on Seller's quote or other documentation offered by Seller are valid for 30 days, and do not include any sales, use, or other taxes unless specifically stated. Unless otherwise specified by Seller, all prices are F.C.A. Seller's facility (INCOTERMS 2010). Payment is subject to credit approval and is due 30 days from the date of invoice or such other term as required by Seller's Credit Department, after which Buyer shall pay interest on any unpaid invoices at the rate of 1.5% per month or the maximum allowable rate under applicable law.

3. Delivery Dates; Title and Risk; Shipment. All delivery dates are approximate and Seller shall not be responsible for any damages resulting from any delay. Regardless of the manner of shipment, title to any products and risk of loss or damage shall pass to Buyer upon placement of the products with the shipment carrier at Seller's facility. Unless otherwise stated, Seller may exercise its judgment in choosing the carrier and means of delivery. No deferment of shipment at Buyers' request beyond the respective dates indicated will be made except on terms that will indemnify, defend and hold Seller harmless against all loss and additional expense. Buyer shall be responsible for any additional shipping charges incurred by Seller due to Buyer's acts or omissions.

4. Warranty. Seller warrants that the Products sold hereunder shall be free from defects in material or workmanship for a period of twelve months from the date of delivery to Buyer or 2,000 hours of normal use, whichever occurs first. The prices charged for Seller's products are based upon the exclusive limited warranty stated above, and upon the following disclaimer: **DISCLAIMER OF WARRANTY: THIS WARRANTY COMPRISES THE SOLE AND ENTIRE WARRANTY PERTAINING TO PRODUCTS PROVIDED HEREUNDER. SELLER DISCLAIMS ALL OTHER WARRANTIES, EXPRESS AND IMPLIED, INCLUDING DESIGN, MERCHANTABILITY AND FITNESS FOR A PARTICULAR PURPOSE.**

5. Claims; Commencement of Actions. Buyer shall promptly inspect all Products upon delivery. No claims for shortages will be allowed unless reported to the Seller within 10 days of delivery. No other claims against Seller will be allowed unless asserted in writing within 30 days after delivery. Buyer shall notify Seller of any alleged breach of warranty within 30 days after the date the defect is or should have been discovered by Buyer. Any action based upon breach of this agreement or upon any other claim arising out of this sale (other than an action by Seller for an amount due on any invoice) must be commenced within 12 months from the date of the breach without regard to the date breach is discovered.

6. LIMITATION OF LIABILITY. UPON NOTIFICATION, SELLER WILL, AT ITS OPTION, REPAIR OR REPLACE A DEFECTIVE PRODUCT, OR REFUND THE PURCHASE PRICE. **IN NO EVENT SHALL SELLER BE LIABLE TO BUYER FOR ANY SPECIAL, INDIRECT, INCIDENTAL OR CONSEQUENTIAL DAMAGES ARISING OUT OF, OR AS THE RESULT OF, THE SALE, DELIVERY, NON-DELIVERY, SERVICING, USE OR LOSS OF USE OF THE PRODUCTS OR ANY PART THEREOF, OR FOR ANY CHARGES OR EXPENSES OF ANY NATURE INCURRED WITHOUT SELLER'S WRITTEN CONSENT, EVEN**

IF SELLER HAS BEEN NEGLIGENT, WHETHER IN CONTRACT, TORT OR OTHER LEGAL THEORY, IN NO EVENT SHALL SELLER'S LIABILITY UNDER ANY CLAIM MADE BY BUYER EXCEED THE PURCHASE PRICE OF THE PRODUCTS.

7. User Responsibility. The user, through its own analysis and testing, is solely responsible for making the final selection of the system and Product and assuring that all performance, endurance, maintenance, safety and warning requirements of the application are met. The user must analyze all aspects of the application and follow applicable industry standards and Product information. If Seller provides Product or system options, the user is responsible for determining that such data and specifications are suitable and sufficient for all applications and reasonably foreseeable uses of the Products or systems.

8. Loss to Buyer's Property. Any designs, tools, patterns, materials, drawings, confidential information or equipment furnished by Buyer or any other items which become Buyer's property, will be considered obsolete and may be destroyed by Seller after two consecutive years have elapsed without Buyer ordering the items manufactured using such property. Seller shall not be responsible for any loss or damage to such property while it is in Seller's possession or control.

9. Special Tooling. A tooling charge may be imposed for any special tooling, including without limitation, dies, fixtures, molds and patterns, acquired to manufacture Products. Such special tooling shall be and remain Seller's property notwithstanding payment of any charges by Buyer. In no event will Buyer acquire any interest in apparatus belonging to Seller which is utilized in the manufacture of the Products, even if such apparatus has been specially converted or adapted for such manufacture and notwithstanding any charges paid by Buyer. Unless otherwise agreed, Seller shall have the right to alter, discard or otherwise dispose of any special tooling or other property in its sole discretion at any time.

10. Buyer's Obligation; Rights of Seller. To secure payment of all sums due or otherwise, Seller shall retain a security interest in the goods delivered and this agreement shall be deemed a Security Agreement under the Uniform Commercial Code. Buyer authorizes Seller as its attorney to execute and file on Buyer's behalf all documents Seller deems necessary to perfect its security interest.

11. Improper use and Indemnity. Buyer shall indemnify, defend, and hold Seller harmless from any claim, liability, damages, lawsuits, and costs (including attorney fees), whether for personal injury, property damage, patent, trademark or copyright infringement or any other claim, brought by or incurred by Buyer, Buyer's employees, or any other person, arising out of: (a) improper selection, improper application or other misuse of Products purchased by Buyer from Seller; (b) any act or omission, negligent or otherwise, of Buyer; (c) Seller's use of patterns, plans, drawings, or specifications furnished by Buyer to manufacture Product; or (d) Buyer's failure to comply with these terms and conditions. Seller shall not indemnify Buyer under any circumstance except as otherwise provided

12. Cancellations and Changes. Orders shall not be subject to cancellation or change by Buyer for any reason, except with Seller's written consent and upon terms that will indemnify, defend and hold Seller harmless against all direct, incidental and consequential loss or damage. Seller may change product features, specifications, designs and availability with notice to Buyer.

13. Limitation on Assignment. Buyer may not assign its rights or obligations under this agreement without the prior written consent of Seller.

14. Force Majeure. Seller does not assume the risk and shall not be liable for delay or failure to perform any of Seller's obligations by reason of circumstances beyond the reasonable control of Seller (hereinafter "Events of Force Majeure"). Events of Force Majeure shall include without limitation: accidents, strikes or labor disputes, acts of any government or government agency, acts of nature, delays or failures in delivery from carriers or suppliers, shortages of materials, or any other cause beyond Seller's reasonable control.

15. Waiver and Severability. Failure to enforce any provision of this agreement will not waive that provision nor will any such failure prejudice Seller's right to enforce that provision in the future. Invalidation of any provision of this agreement by legislation or other rule of law shall not invalidate any other provision herein. The remaining provisions of this agreement will remain in full force and effect.

16. Termination. Seller may terminate this agreement for any reason and at any time by giving Buyer thirty (30) days written notice of termination. Seller may immediately terminate this agreement, in writing, if Buyer: (a) commits a breach of any provision of this agreement (b) appoints a trustee, receiver or custodian for all or any part of Buyer's property (c) files a petition for relief in bankruptcy on its own behalf, or by a third party (d) makes an assignment for the benefit of creditors, or (e) dissolves or liquidates all or a majority of its assets.

17. Governing Law. This agreement and the sale and delivery of all Products hereunder shall be deemed to have taken place in and shall be governed and construed in accordance with the laws of the State of Ohio, as applicable to contracts executed and wholly performed therein and without regard to conflicts of laws principles. Buyer irrevocably agrees and consents to the exclusive jurisdiction and venue of the courts of Cuyahoga County, Ohio with respect to any dispute, controversy or claim arising out of or relating to this agreement.

18. Indemnity for Infringement of Intellectual Property Rights. Seller shall have no liability for infringement of any patents, trademarks, copyrights, trade dress, trade secrets or similar rights except as provided in this Section. Seller will defend and indemnify Buyer against allegations of infringement of U.S. patents, U.S. trademarks, copyrights, trade dress and trade secrets ("Intellectual Property Rights"). Seller will defend at its expense and will pay the cost of any settlement or damages awarded in an action brought against Buyer based on an allegation that a Product sold pursuant to this Agreement infringes the Intellectual Property Rights of a third party. Seller's obligation to defend and indemnify Buyer is contingent on Buyer notifying Seller within ten (10) days after Buyer becomes aware of such allegations of infringement, and Seller having sole control over the defense of any allegations or actions including all negotiations for settlement or compromise. If a Product is subject to a claim that it infringes the Intellectual Property Rights of a third party, Seller may, at its sole expense and option, procure for Buyer the right to continue using the Product, replace or modify the Product so as to make it noninfringing, or offer to accept return of the Product and return the purchase price less a reasonable allowance for depreciation. Notwithstanding the foregoing, Seller shall have no liability for claims of infringement based on information provided by Buyer, or directed to Products delivered hereunder for which the designs are specified in whole or part by Buyer, or infringements resulting from the modification, combination or use in a system of any Product sold hereunder. The foregoing provisions of this Section shall constitute

Seller's sole and exclusive liability and Buyer's sole and exclusive remedy for infringement of Intellectual Property Rights.

19. Entire Agreement. This agreement contains the entire agreement between the Buyer and Seller and constitutes the final, complete and exclusive expression of the terms of sale. All prior or contemporaneous written or oral agreements or negotiations with respect to the subject matter are herein merged.

20. Compliance with Law, U. K. Bribery Act and U.S. Foreign Corrupt Practices Act. Buyer agrees to comply with all applicable laws and regulations, including both those of the United Kingdom and the United States of America, and of the country or countries of the Territory in which Buyer may operate, including without limitation the U. K. Bribery Act, the U.S. Foreign Corrupt Practices Act ("FCPA") and the U.S. Anti-Kickback Act (the "Anti-Kickback Act"), and agrees to indemnify and hold harmless Seller from the consequences of any violation of such provisions by Buyer, its employees or agents. Buyer acknowledges that they are familiar with the provisions of the U. K. Bribery Act, the FCPA and the Anti-Kickback Act, and certifies that Buyer will adhere to the requirements thereof. In particular, Buyer represents and agrees that Buyer shall not make any payment or give anything of value, directly or indirectly to any governmental official, any foreign political party or official thereof, any candidate for foreign political office, or any commercial entity or person, for the purpose of influencing such person to purchase products or otherwise benefit the business of Seller.

Parker's Motion & Control Product Groups

At Parker, we're guided by a relentless drive to help our customers become more productive and achieve higher levels of profitability by engineering the best systems for their requirements. It means looking at customer applications from many angles to find new ways to create value. Whatever the motion and control technology need, Parker has the experience, breadth of product and global reach to consistently deliver. No company knows more about motion and control technology than Parker. For further info call 1 800 C-Parker (1 800 272 7537).



Aerospace

Key Markets

Aftermarket services
Commercial transports
Engines
General & business aviation
Helicopters
Launch vehicles
Military aircraft
Missiles
Power generation
Regional transports
Unmanned aerial vehicles

Key Products

Control systems & actuation products
Engine systems & components
Fluid conveyance systems & components
Fluid metering, delivery & atomization devices
Fuel systems & components
Fuel tank inerting systems
Hydraulic systems & components
Thermal management
Wheels & brakes



Automation

Key Markets

Alternative energy
Conveyor & material handling
Factory automation
Food & beverage
Life sciences & medical
Machine tools
Packaging machinery
Paper machinery
Plastics machinery
Primary metals
Safety & security
Semiconductor & electronics
Transportation & automotive

Key Products

AC/DC drives & systems
Air preparation
Electric actuators, gantry robots & slides
Human machine interfaces
Inverters
Manifolds
Miniature fluidics
Pneumatic actuators & grippers
Pneumatic valves & controls
Rotary actuators
Stepper motors, servo motors, drives & controls
Structural extrusions
Vacuum generators, cups & sensors



Climate & Industrial Controls

Key Markets

Agriculture
Air conditioning
Construction Machinery
Food & beverage
Industrial machinery
Life sciences
Oil & gas
Precision cooling
Process
Refrigeration
Transportation

Key Products

Accumulators
Advanced actuators
CO₂ controls
Electronic controllers
Filter driers
Hand shut-off valves
Heat exchangers
Hose & fittings
Pressure regulating valves
Refrigerant distributors
Safety relief valves
Smart pumps
Solenoid valves
Thermostatic expansion valves



Filtration

Key Markets

Aerospace
Food & beverage
Industrial plant & equipment
Life sciences
Marine
Mobile equipment
Oil & gas
Power generation & renewable energy
Process
Transportation
Water Purification

Key Products

Analytical gas generators
Compressed air filters & dryers
Engine air, coolant, fuel & oil filtration systems
Fluid condition monitoring systems
Hydraulic & lubrication filters
Hydrogen, nitrogen & zero air generators
Instrumentation filters
Membrane & fiber filters
Microfiltration
Sterile air filtration
Water desalination & purification filters & systems



Fluid Connectors

Key Markets

Aerial lift
Agriculture
Bulk chemical handling
Construction machinery
Food & beverage
Fuel & gas delivery
Industrial machinery
Life sciences
Marine
Mining
Mobile
Oil & gas
Renewable energy
Transportation

Key Products

Check valves
Connectors for low pressure fluid conveyance
Deep sea umbilicals
Diagnostic equipment
Hose couplings
Industrial hose
Mooring systems & power cables
PTFE hose & tubing
Quick couplings
Rubber & thermoplastic hose
Tube fittings & adapters
Tubing & plastic fittings



Hydraulics

Key Markets

Aerial lift
Agriculture
Alternative energy
Construction machinery
Forestry
Industrial machinery
Machine tools
Marine
Material handling
Mining
Oil & gas
Power generation
Refuse vehicles
Renewable energy
Truck hydraulics
Turf equipment

Key Products

Accumulators
Cartridge valves
Electrohydraulic actuators
Human machine interfaces
Hybrid drives
Hydraulic cylinders
Hydraulic motors & pumps
Hydraulic systems
Hydraulic valves & controls
Hydrostatic steering
Integrated hydraulic circuits
Power take-offs
Power units
Rotary actuators
Sensors



Instrumentation

Key Markets

Alternative fuels
Biopharmaceuticals
Chemical & refining
Food & beverage
Marine & shipbuilding
Medical & dental
Microelectronics
Nuclear Power
Offshore oil exploration
Oil & gas
Pharmaceuticals
Power generation
Pulp & paper
Steel
Water/wastewater

Key Products

Analytical Instruments
Analytical sample conditioning products & systems
Chemical injection fittings & valves
Fluoropolymer chemical delivery fittings, valves & pumps
High purity gas delivery fittings, valves, regulators & digital flow controllers
Industrial mass flow meters/ controllers
Permanent no-weld tube fittings
Precision industrial regulators & flow controllers
Process control double block & bleeds
Process control fittings, valves, regulators & manifold valves



Seal

Key Markets

Aerospace
Chemical processing
Consumer
Fluid power
General industrial
Information technology
Life sciences
Microelectronics
Military
Oil & gas
Power generation
Renewable energy
Telecommunications
Transportation

Key Products

Dynamic seals
Elastomeric o-rings
Electro-medical instrument design & assembly
EMI shielding
Extruded & precision-cut, fabricated elastomeric seals
High temperature metal seals
Homogeneous & inserted elastomeric shapes
Medical device fabrication & assembly
Metal & plastic retained composite seals
Shielded optical windows
Silicone tubing & extrusions
Thermal management
Vibration dampening



ENGINEERING YOUR SUCCESS.

Parker Fluid Connectors Group

North American Divisions & Distribution Service Centers

Your complete source for quality tube fittings, hose & hose fittings, brass & composite fittings, quick-disconnect couplings, valves and assembly tools, locally available from a worldwide network of authorized distributors.

Fittings:

Available in inch and metric sizes covering SAE, BSP, DIN, GAZ, JIS and ISO thread configurations, manufactured from steel, stainless steel, brass, aluminum, nylon and thermoplastic.

Hose, Tubing and Bundles:

Available in a wide variety of sizes and materials including rubber, wire-reinforced, thermoplastic, hybrid and custom compounds.

Worldwide Availability:

Parker operates Fluid Connectors manufacturing locations and sales offices throughout North America, South America, Europe and Asia-Pacific.

For information, call toll free...

1-800-C-PARKER
(1-800-272-7537)

North American Divisions

Energy Products Division

Stafford, TX
phone 281 566 4500
fax 281 530 5353

Fluid System Connectors Division

Otsego, MI
phone 269 694 9411
fax 269 694 4614

Hose Products Division

Wickliffe, OH
phone 440 943 5700
fax 440 943 3129

Industrial Hose Division

Strongsville, OH
phone 440 268 2120
fax 440 268 2230

Parflex Division

Wickliffe, OH
phone 440 833 2120
fax 440 833 2230

Quick Coupling Division

Minneapolis, MN
phone 763 544 7781
fax 763 544 3418

Tube Fittings Division

Columbus, OH
phone 614 279 7070
fax 614 279 7685

Distribution Service Centers

Buena Park, CA

phone 714 522 8840
fax 714 994 1183

Conyers, GA

phone 770 929 0330
fax 770 929 0230

Louisville, KY

phone 502 937 1322
fax 502 937 4180

Portland, OR

phone 503 283 1020
fax 503 283 2201

Toledo, OH

phone 419 878 7000
fax 419 878 7001
fax 419 878 7420
(FCG Kit Operations)

Canada

Grimsby, ONT

phone 905 945 2274
fax 905 945 3945
(Contact Grimsby for other Service Center locations.)



Parker Hannifin Corporation
Parflex Division/PAGE International Hose
4700 Lone Star Blvd.
Fort Worth, TX 76106
phone 817.624.1329 800.847.7280
fax 817.625.1901 888.293.2667
email: page@parker.com

